

Product Catalog Asia-Pacific



Private networks (Enterprise, Industrial, Residential)

Public networks (Carrier)



Convincing cabling solutions

Data Center Solutions at R&M



1U ANGLED PATCH PANELS 24-PORT

- Shortens distance from connectors to side vertical cable managers
- Speed up installation process
- Cable tie shelf serves as a strong backbone, with rounded edges for extra stability
- Highly visible and firmly integrated, it makes network management easier
- Comprehensive protection and security are built-in with accessories from R&M

19" MPO / MTP® Panel

- Easy handling (plug and play)
- Integrated bending radius limiter
- High packing density, up to 96 connectors per 1U patch panel
- Little mounting depth of 230 mm
- Universally compatible (e.g. ETSI standard compliant)

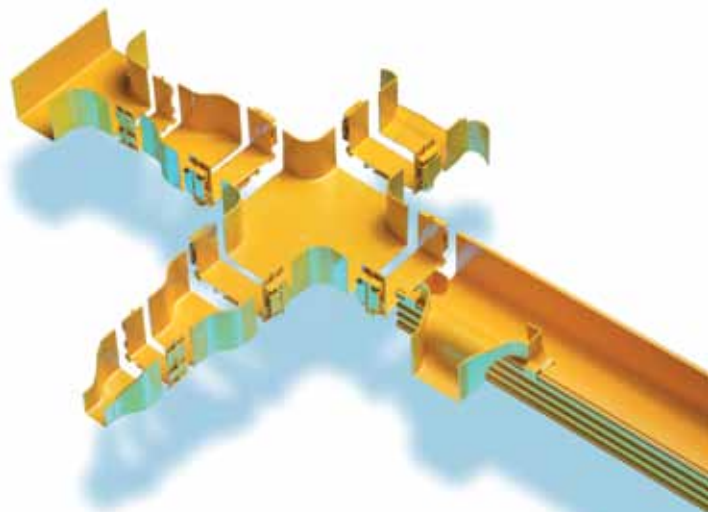
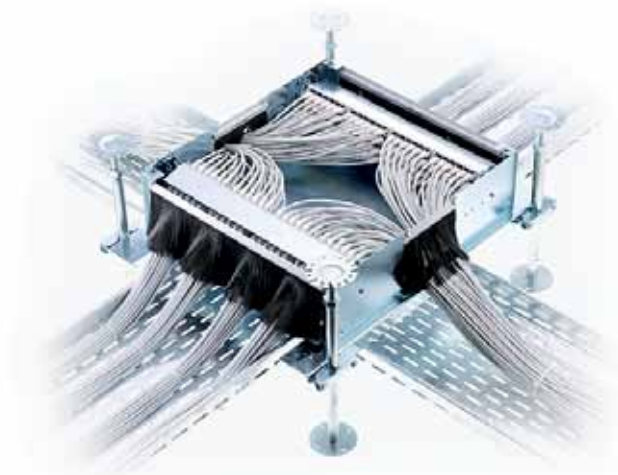

RAISED FLOOR BOX

- Serves as zone distributor area (ZDA) or consolidation point in data centers
- Installed in the raised floor, the housing offers room for 288 connections
- The steel housing neatly fits the 600x600 millimeter grid dimensions
- Advantageous for the space requirements in 19" distribution cabinets

RACEWAY SYSTEM

- Simple retrofit of covers
- Snap-on joints link the individual components together
- Flame-retardant material: plastic PC/ABS
- Standard color yellow

The R&M guarantee system

THE THREE-LEVEL R&M GUARANTEE SYSTEM

R&M guarantees security for the future. As a certified R&M partner, you can pass on this guarantee in three levels – as true added value.

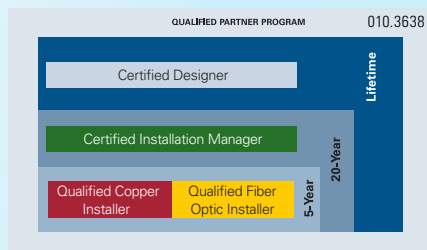

THE FIVE-YEAR PRODUCT GUARANTEE

This guarantees that passive R&Mfreenet components will operate free of errors during the guarantee period and will exceed the requirements of all relevant cabling norms. Anyone who buys passive R&Mfreenet components will benefit from this protection.

THE 20-YEAR SYSTEM GUARANTEE

This covers the entire R&Mfreenet cabling system and protects the end customer from component failures and installation problems. This guarantee is granted if the LAN cabling system consists exclusively of passive R&Mfreenet components and the entire installation is performed by a certified R&Mfreenet installer (or by an entity provided with more training by the QPP).

THE LIFELONG APPLICATION GUARANTEE

This guarantee requires that the passive R&Mfreenet cabling system be planned by a certified designer. It includes the promise that all protocols supported by industry standards will run on the system for its entire lifetime. No matter what requirements your end customers may stipulate, you can trust R&Mfreenet-certified partners.

For more information on certified partners, courses, guarantees and service programs, please visit www.rdm.com.

Contents



Contents	Page
----------	------

Copper Systems

Connection Systems	1
Installation Cables	8
Patch Panels	14
Patch Cords	30
DRM45	34
Outlets	35
Connection Boxes	46
Security System	47
Cable Routing	51

FO Systems

Connection Systems	52
Patch Cords / Pigtailed	57
Installation Cables	59
Cable Routing	60
Patch Panels	61
MPO Module	64
MPO Panel	65
Trunk Cable/Harness Cable MPO / MTP®	66
Splice Trays	67
Security System	69

VS Compact

Connection Systems	70
Indoor Distributors	75
Patch and Connection Cords	77
Tools / Test Equipment	78

Index	79
-------	----

Get more with R&M

R&M is one of the leading providers of passive cabling solutions for high quality communication networks. Worldwide, the company makes a crucial contribution to operational security in speech, data, and image transmission with copper and fiber-optic systems. As a system provider, R&M has set itself the goal of developing optimal functionality and, above all, fulfilling the highest quality criteria. In addition, R&M offers maximum installation and maintenance convenience. R&M solutions display their superiority through maximum availability with economical network operation. With high product quality and forward-looking design, R&M ensures that the networks will be capable in the future and that investments are secure in the long-term. R&M cabling solutions are used in office buildings, at network operators, in homes and in industry.

GET MORE: SUCCESS

High-performance, reliable communication networks are decisive success factors for our customers. They expect investments in infrastructure to have a positive effect on profits, whether through higher productivity, reduced downtime costs or lower maintenance costs. This is why we do everything in our power to make our customers successful.

GET MORE: CONTINUITY

R&M is an independent Swiss family company and is wholly owned by the Reichle family. Since it was founded in 1964, the company has concentrated on the development and manufacture of passive cabling systems for communication networks (layer 1). Since 1999, R&M has been run by the second generation, Martin and Peter Reichle. Our decisions are not subject to short-term profit considerations: rather, we invest in long-term company development. In this way, our customers always know where they stand.



GET MORE: SECURITY

Our products and services are aimed at greater stability and availability of networks. We achieve this through unique product quality. This guarantees long life and high performance. In addition, we intensively support planners, installers and end customers in system design, advise on the selection of systems and, on request, steer projects up to commissioning. In this way, we can influence the quality of the entire service performed.

GET MORE: INNOVATION

At R&M, great value is placed on research and development. For over 45 years, we have bundled competency in the fields of high-frequency technology and fiber optics. This is a unique basis for ongoing innovation. We participate in the formulation of many international standards and recognize trends at an early stage. Our proximity to our partners enables us to develop innovative products, solutions, and services that meet customers' needs. Our system solutions set benchmarks with regard to modularity, application variety and flexibility. Our customers benefit from forward-thinking solutions that will also master future challenges.

GET MORE: QUALITY

Only goal-oriented quality management guarantees the constant improvement of products, services, and internal processes. R&M partners benefit worldwide from the uniformly high Swiss quality standard. The consistent quality philosophy can be seen in recognized certifications such as EN ISO 9001:2000. The competency of the R&M employees and the production expertise of R&M's suppliers are the pillars of our quality management system. For us, quality includes the responsible handling of resources and the protection of humans and the environment.

GET MORE: FLEXIBILITY

Special tasks require special solutions. In such cases, we develop individual products and special service packages together with our customers. With our international organization, we are large enough to implement this flexibility everywhere on-site. But we are also small and dynamic enough to be able to react quickly and unbureaucratically to customer wishes.

GET MORE: TEAM SPIRIT

We live the R&M family spirit. Our customers notice this and it benefits them immediately. They recognize R&M employees by their distinctive customer orientation. With short decision paths and collegial, team-oriented working manner, we promote individual initiative and creativity for the advantage of the customer.

GET MORE: CUSTOMER PROXIMITY

We believe in proximity to our customers, no matter where they may be. You will find us on the spot wherever people work with our products. This proximity to our customers enables us to recognize today the demands, trends, and developments that will move the market tomorrow. In addition to selecting the right product, the cabling must be professionally planned, installed and operated for the network solution to meet all customer demands. These are crucial factors that R&M takes into account. We have established a global network of competent R&M partners who professionally advise customers on-site and provide the ideal solution for the situation at hand.

Connection Systems
RJ45 Connection Modules Cat.6A ISO



Features

- Exceeds the Cat.6A ISO specification (mated) for the entire re-embedded plug range as specified by IEC 60603-7-51 (shielded), 60603-7-41 (unshielded) and IEC 60512-27-100. Exceeds the Cat.6A specification (mated) for the entire re-embedded plug range as specified by TIA/EIA 568-C.2
- Achieves exceptional margins when installed as part of an R&M Cat.6A ISO 4-connector channel or permanent link, exceeding the IEEE 802.3an minimum requirements for 10GBASE-T performance, as well as the requirements for Class EA performance according to ISO/IEC 11801 ed. 2002, Amendment 1 and 2, and Cat.6A performance according to TIA/EIA 568-C.2
- Automatic cutting of wires for precise, consistent termination



Ordering Information

Description

PU

Part Number



Connection Module Cat.6A ISO, RJ45/s

Supplied:

- RJ45 Cat.6A ISO connection module, shielded
- Mounting plate
- EMC cover
- Dust cover
- Cable tie
- Installation instructions

10x

10

R509504

100x

100

R509505



Connection Module Cat.6A ISO, RJ45/u

Supplied:

- RJ45 Cat.6A ISO connection module, unshielded
- Mounting plate
- Dust cover
- Cable tie
- Installation instructions

10x

10

R509500

100x

100

R509501



Connection Module Cat.6A ISO, RJ45/s, Snap-in

Supplied:

- RJ45 Cat.6A ISO connection module, shielded
- Snap-in adapter
- EMC cover
- Dust cover
- Cable tie
- Installation instructions

10x

10

R509506

24x (Black)

24

R511999

100x

100

R509507



Connection Module Cat.6A ISO, RJ45/u, Snap-in

Supplied:

- RJ45 Cat.6A ISO connection module, unshielded
- Snap-in adapter
- Dust cover
- Cable tie
- Installation instructions

10x

10

R509502

24x (Black)

24

R511998

100x

100

R509503

Ordering Information

Description

PU

Part Number

090.5451



Connection Module Cat.6A ISO, 1xRJ45/s, Keystone

Supplied:

- RJ45 Cat.6A ISO connection module, unshielded, with Keystone adapter
- EMC cover
- Dust cover
- Cable tie
- Installation instructions

10x

10

R509509

090.5450



Connection Module Cat.6A ISO, 1xRJ45/u, Keystone

Supplied:

- RJ45 Cat.6A ISO connection module, unshielded, with Keystone adapter
- Dust cover
- Cable tie
- Installation instructions

10x

10

R509508

090.5611



Parallel pliers

- Optional tool for termination of the Cat.6A ISO connection module.
- Jaw opening: 0 - 35mm

10x

10

R510833

Dimensions, shielded

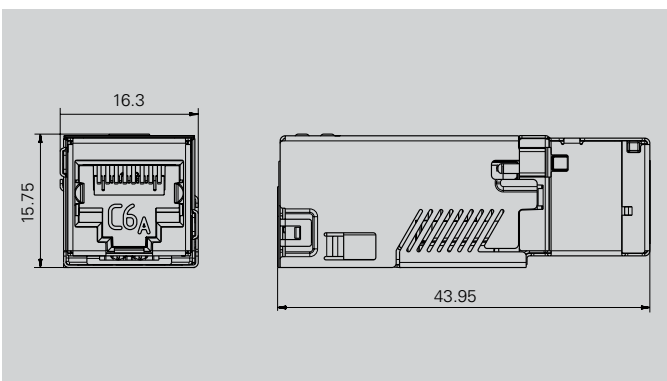

Dimensions, unshielded

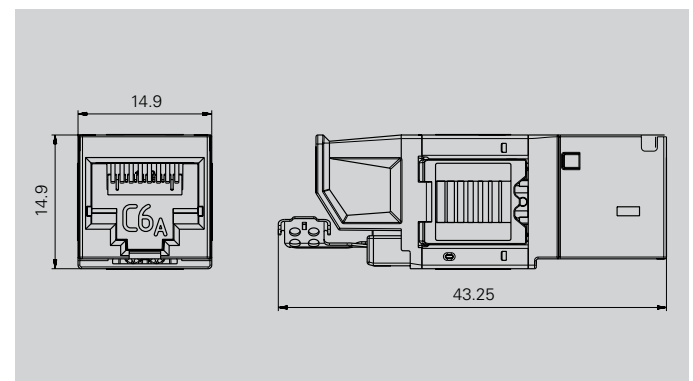

Connection Systems
RJ45 Connection Modules Cat.6
Real10 Cat.6

010.2857



Features

- As part of a Real10 Cat.6 channel, the Real10 connection module exceeds the minimum requirements of the IEEE 802.3an standard on 10GBASE-T performance, as well as the requirements for Class EA performance acc. to ISO/IEC 11801 ed. 2002, Amendment 1
- Exceeds Cat.6 specifications acc. to ISO/IEC 11801, EN 50173 and TIA/EIA 568B in the entire admissible range
- Maximum reliability through special contact design without internal transfer points
- Capacitive and inductive compensation
- Delta, GHMT and 3P certified

i Special packing unit for installers

Connection modules 100xRJ45. Saves time and waste.

¹⁾Approval: UL

Ordering Information

Description

PU

Part Number

010.2857



Connection Module Cat.6

- Supplied:
- RJ45 Cat.6 connection module, unshielded
 - Mounting plate
 - Dust cover
 - Cable tie
 - Installation instructions

1xRJ45/u ¹⁾

10

R302373

100xRJ45/u

100

R304328

090.2213



Connection Module Real10 Cat.6

- Supplied:
- RJ45 Real10 Cat.6 connection module, unshielded
 - Mounting plate
 - WARP cover
 - Dust cover
 - Cable tie
 - Installation instructions

1xRJ45/u

10

R313064

100xRJ45/u

100

R313083

010.2859



Connection Module Real10 Cat.6

- Supplied:
- RJ45 Real10 Cat.6 connection module, shielded
 - Mounting plate
 - EMC cover
 - Dust cover
 - Cable tie
 - Installation instructions

1xRJ45/s ¹⁾

10

R302372

100xRJ45/s

100

R304327

010.2017.1



Connection Module Cat.6

- Supplied:
- RJ45 Cat.6 connection module, unshielded
 - Snap-in adapter
 - Dust cover
 - Cable tie
 - Installation instructions

1xRJ45/u, Snap-in ¹⁾	10	<i>R304374</i>
24xRJ45/u, Snap-in (Black)	24	R512369
100xRJ45/u, Snap-in	100	<i>R308734</i>

090.2321



Connection Module Real10 Cat.6

- Supplied:
- RJ45 Real10 Cat.6 connection module, unshielded
 - Snap-in adapter
 - WARP cover
 - Dust cover
 - Cable tie
 - Installation instructions

1xRJ45/u, Snap-in	10	<i>R313090</i>
--------------------------	----	----------------

010.2016.1



Connection Module Real10 Cat.6

- Supplied:
- RJ45 Real10 Cat.6 connection module, shielded
 - Snap-in adapter
 - EMC cover
 - Dust cover
 - Cable tie
 - Installation instructions

1xRJ45/s, Snap-in ¹⁾	10	<i>R304373</i>
24xRJ45/s, Snap-in (Black)	24	R512370
100xRJ45/s, Snap-in	100	<i>R308732</i>

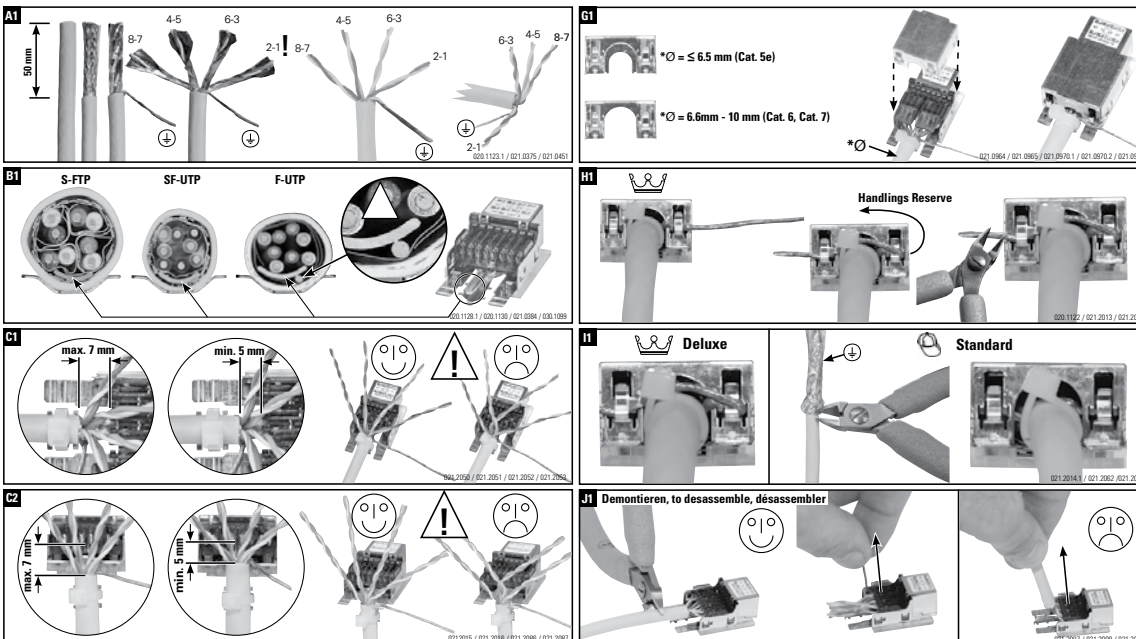

Connection Systems
RJ45 Connection Modules Cat.5e



Features

- Compliant with Cat.5e requirements of relevant cabling standards (ISO/IEC 11801, EN 50173 and TIA/EIA 568B)
- Reach Cat.5e values of IEC 60603-7 together with R&M Cat.5e patch cords of the R&Mfreenet cabling system
- 3dB better NEXT values at 100 MHz than Cat.5 (1995)
- Compatible with Cat.5e standard plugs
- SGS certified

i Special packing unit for installers

Connection modules 100xRJ45. Saves time and waste.

¹⁾Approval: UL

Ordering Information

Description

PU

Part Number



Connection Module Cat.5e

Supplied:

- RJ45 Cat.5e connection module, unshielded
- Mounting plate
- Dust cover
- Cable tie
- Installation instructions

1xRJ45/u ¹⁾

10

R925371

100xRJ45/u ¹⁾

100

R304326



Connection Module Cat.5e

Supplied:

- RJ45 Cat.5e connection module, shielded
- Mounting plate
- EMC cover
- Dust cover
- Cable tie
- Installation instructions

1xRJ45/s ¹⁾

10

R925370

100xRJ45/s

100

R304325



Connection Module Cat.5e

Supplied:

- RJ45 Cat.5e connection module, unshielded
- Snap-in adapter
- Dust cover
- Cable tie
- Installation instructions

1xRJ45/u, Snap-in ¹⁾

10

R302518

100xRJ45/u, Snap-in ¹⁾

100

R308733



Connection Module Cat.5e

Supplied:

- RJ45 Cat.5e connection module, shielded
- Snap-in adapter
- EMC cover
- Dust cover
- Cable tie
- Installation instructions

1xRJ45/s, Snap-in ¹⁾

10

R302780

100xRJ45/s, Snap-in

100

R308731

090.2849



Features

- Maximum use of the horizontal cabling
- Based on the RJ45 connection system
- Fully compatible with the R&Mfreenet cabling system
- Suitable for shielded and unshielded cabling
- Integral color coding
- Inherent connection system

Ordering Information

Description

PU

Part Number

090.2854



RMS45 Microsplitter Insert, shielded

- Matching all R&Mfreenet RJ45 connection modules Cat.5e and Cat.6
 - Employable on the patch panel as well as at the workplace outlet
 - Allows the inherent cable sharing of up to four services by using RJ45 connectors
 - Tool-free mounting
- Supplied:
- RMS45 insert
 - Color coding: green and yellow
 - Installation instructions

2

R319034

090.2853



RMS45 Plug 1-Pair, unshielded

- Field-terminated 1-pair plug, unshielded
 - Fast and simple connecting, requiring no special tools
- Cable information:
- Telephone ribbon cables 2.5x5 mm
 - Round cables up to Ø 3.4 mm
 - Patch wires 2x0.5 mm
 - Wires and strands AWG26-24
 - Conductor insulation max. Ø 1.1 mm

10

R319035

090.2852

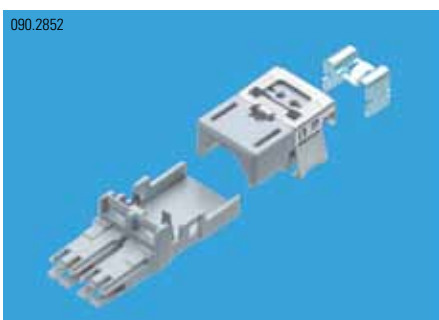

RMS45 Plug 2-Pair, shielded

- Field-terminated 2-pair plug, shielded
 - Fast and simple connecting
- Cable information:
- Round cables Ø 3.2 mm up to Ø 5.5 mm
 - Wires and strands AWG26-24
 - Conductor insulation max. Ø 1.1 mm

10

R319036

090.2900



Adapter Cord Cat.5e, SF/UTP, 2P, LSFRZH, RMS45-RJ45/s (4-5 3-6)

- Shielded Cat.5e patch cord for Token Ring, ISDN and CATV
- Cable: SF/UTP
- Outer jacket: LSFRZH
- Color coding: green, TIA/EIA 568A

1.0 m

10

R319057

2.0 m

10

R319058

3.0 m

10

R319059

5.0 m

10

R319060

Connection Systems
FM45 IP20 / IP65 / IP67
Field Termination

090.3248



Features

- First tool-free, field-terminated Cat.5e/RJ45 connector
- Wide range of applications, dependable solid construction, highest Swiss quality
- Accepts unshielded (U/UTP) and shielded (S/FTP) cables up to 8 mm in diameter, and wires or strands up to AWG 26 to AWG 22
- Long-term stability, vibration resistance, strain relief and the possibility of repeated termination provided by IDC conductor contacting plus quick mounting technique
- Cable shield EMC protection > 180°
- Optical coding with color coding clips

i ¹⁾Approval: UL

Ordering Information

Description

PU

Part Number

090.3026



FM45 Connector IP20

- Field-terminated RJ45 connector with housing
- Color: traffic gray (RAL 7042)

Supplied:

- RJ45 connector kit
- Housing IP20
- Instruction manual

4P, TIA 568A ¹⁾

10

R312231

4P, TIA 568B ¹⁾

10

R320374

090.3021



FM45 IP65 - IP67

- Field-terminated RJ45 connector for IP67 connector housing Interbus

Supplied:

- RJ45 connector kit
- Instruction manual

4P, TIA 568A

1

R320375

4P, TIA 568B

1

R320376

090.3179



FM45 Connector Housing IP67 Interbus

- Connector housing, empty, to be fitted with shielded or unshielded FM45 plug connectors
- Housing material: plastic (PA)
- Color: gray

1

R320691

020.0983



Features

- 100 Ohm installation cable
- Suitable for voice, video and data transmission
- For frequencies from 750 MHz up to 1500 MHz

Ordering Information

Description

PU

Part Number

020.0983



Installation Cable Real10 Cat.7, S/FTP

- Real10 Cat.7, S/FTP cable
- Foil and tin-plated copper braid shielding
- 100 Ohm impedance

- 4P, 750 MHz, LSZH, 500 m**
- 4P, 900 MHz, LSFRZH, 500 m**
- 4P, 1000 MHz, LSFRZH, 500 m**
- 4P, 1200 MHz, LSFRZH, 500 m**
- 4P, 1500 MHz, LSFRZH, 500 m**

- 500
- 500
- 500
- 500
- 500

- R35257
- R35060
- R319522
- R306257
- R507032

ON FITS ALL

GET MORE.
 Maximum reliability thanks to IDC. Can be terminated without tools. More freedom in cabling.

 **R&M**
 Convincing cabling solutions

Installation Cables
Installation Cables Cat.6
Real10 Cat.6 and Cat.6

010.2856



Features

- 100 Ohm installation cable
- Suitable for voice, video and data transmission
- Real10 Cat.6 is suitable for transmission frequencies of up to 650 MHz and complies with the 10GBase-T requirements of IEEE802.3an
- Cat.6 is suitable for transmission frequencies of up to 450 MHz

Ordering Information

Description

PU

Part Number

090.5141



Installation Cable Real10 Cat.6A, U/UTP

- 100 Ohm impedance
- Data transmission frequencies of up to 650 MHz

4P, 650MHz, LSZH, 305m

305

R504252

010.2856



Installation Cable Real10 Cat.6, U/FTP

- Real10 Cat.6, U/FTP cable
- Foil-shielded pairs
- 100 Ohm impedance
- Data transmission frequencies of up to 650 MHz

4P, 650 MHz, LSZH, 500 m

500

R308247

020.0983



Installation Cable Real10 Cat.6, S/FTP

- Real10 Cat.6, S/FTP cable
- Foil and tin-plated copper braid shielding of pairs
- 100 Ohm impedance
- Data transmission frequencies of up to 650 MHz

4P, 650 MHz, LSZH, 500 m

500

R305649

010.1560

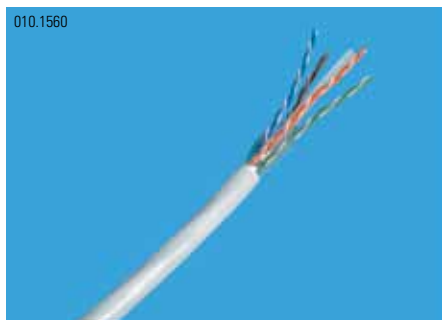

Installation Cable Cat.6, U/UTP

- Cat.6, U/UTP cable
- 100 Ohm impedance
- Data transmission frequencies of up to 450 MHz

4P, 450 MHz, PVC, 500 m

500

R35056

4P, 450 MHz, LSZH, 500 m

500

R35057



020.0983

Features

- Industrial installation cables for extreme environmental conditions
- Water and oil repellent
- Suitable for indoor and outdoor installations

Ordering Information

Description

PU

Part Number



020.0983

Installation Cable Cat.5e, S/FTP

- Standards: EN 50173, ISO/IEC 11801, EN 50288-2-1
- Fire classification: IEC 61034, IEC 60754, IEC 60332-3C
- Oil resistance: standard CEI 20.34, 4 hours, 70 °C in oil
- Temperature range: -20 °C to 60 °C
- Color: RAL 7035
- Cat.5e, S/FTP cable
- Foil and tin-plated copper braid shielding
- 100 Ohm impedance
- Data transmission frequency up to 200 MHz

4P, 200 MHz, LSFRZH, 500 m

500

R309319

SWISSN=SS

GET MORE. Top quality for your investments. Thanks to the proverbial Swiss safety-first approach.

R&M
Convincing cabling solutions

Installation Cables
Installation Cables Cat.5e

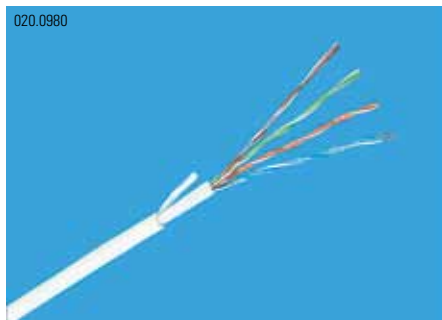

Features

- 100 Ohm installation cable
- Suitable for voice, video and data transmission
- For frequencies of up to 200 MHz

Ordering Information

Description

PU

Part Number

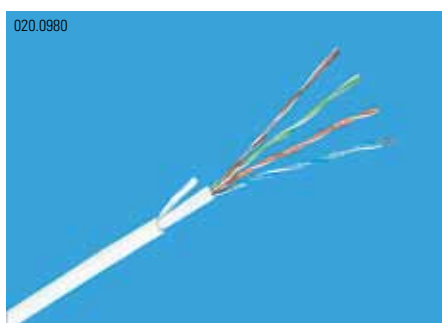

Installation Cable Cat.5e, U/UTP

- Cat.5e, U/UTP cable
- 100 Ohm impedance
- Data transmission frequencies of up to 200 MHz

4P, 200 MHz, PVC, 500 m	500	R35044
4P, 200 MHz, LSZH, 500 m	500	R35045
4P, 200 MHz, PVC, 305 m	305	R35291
4P, 200 MHz, PVC, 305 m, blue	305	R795030
4P, 200 MHz, LSZH, 305 m	305	R35292

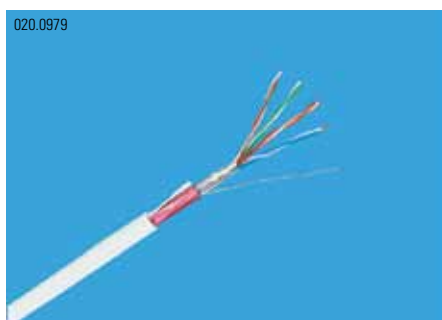

Installation Cable Cat.5e, F/UTP

- Cat.5e, F/UTP cable
- Aluminum foil shielding
- Tin-plated copper drain wire
- 100 Ohm impedance
- Data transmission frequencies of up to 200 MHz

4P, 200 MHz, LSZH, 500 m	500	R35049
4P, 200 MHz, PVC, 305 m	305	R300317



Installation Cable Cat.5e, SF/UTP

- Cat.5e, SF/UTP cable
- Aluminum foil and tin-coated copper braid shielding
- 100 Ohm impedance
- Data transmission frequencies of up to 200 MHz

4P, 200 MHz, PVC, 500 m	500	R35052
4P, 200 MHz, LSZH, 500 m	500	R302089
4P, 200 MHz, LSFRZH, 500 m	500	R35053

020.0978



Multipair Installation Cable Cat.5e, U/UTP

- Recommended applications:
- IEEE 802.3: 10 Base-T, 100 Base-T, ISDN, xDSL
 - IEEE 802.5 16 MB: ISDN, TPDDI, ATM 155 Mbit/s
- Standards:
- EN 50173, ISO/IEC 11801
- Features:
- Multipair, Cat.5e, U/UTP cable
 - 100 Ohm impedance
 - Data transmission frequencies of up to 100 MHz

25P, LSZH, 300 m	300	R310918
50P, LSZH, 300 m	300	R310916
100P, LSZH, 300 m	300	R310917

020.0978



Multipair Installation Cable Cat.5e, F/UTP

- Recommended applications:
- IEEE 802.3: 10 Base-T, 100 Base-T, ISDN, xDSL
 - IEEE 802.5 16 MB: ISDN, TPDDI, ATM 155 Mbit/s
- Standards:
- EN50173, ISO/IEC 11801
- Features:
- Multipair, Cat.5e, F/UTP cable
 - 100 Ohm impedance
 - Data transmission frequencies of up to 100 MHz

25P, LSZH, 300 m	300	R310908
50P, LSZH, 300 m	300	R310920
100P, LSZH, 300 m	300	R310921

Cable designations acc. to ISO/IEC-11801 (2002)

List of reference

Old designations	New designations
UTP	U/UTP
FTP	F/UTP
S-FTP	SF/UTP
S-STP	S/FTP

Legend

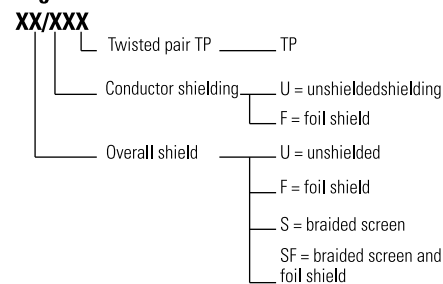

Installation Cables
Installation Cables Cat.3
Multipair



Features

- Suitable for voice, video and data transmission
- Outer sheath LSZH, flame-retardant and zero halogen, compliant with IEC 60332-1 / IEC 60754-2 / IEC 61034
- For data transmission frequencies of up to 16 MHz

Ordering Information

Description

PU

Part Number



Multipair Installation Cable Cat.3, U/UTP

- Multipair, Cat 3, U/UTP cable
- 100 Ohm impedance
- Data transmission frequencies of up to 16 MHz

25P, LSZH, 300 m

1

R311322

50P, LSZH, 300 m

1

R311319

100P, LSZH, 300 m

1

R311320



Multipair Installation Cable Cat.3, F/UTP

- Multipair, Cat.3, F/UTP cable
- 100 Ohm impedance
- Data transmission frequencies of up to 16 MHz

25P, LSZH, 300 m

1

R311321

50P, LSZH, 300 m

1

R311323

100P, LSZH, 300 m

1

R311324

010.2175



Features

- Modular design with the capacity of holding 16 x shielded or unshielded single RJ45 connection modules
- Snap-in jumpering brackets
- Integrated cable tie shelf
- Shielded versions come with a complete and integrated grounding system
- Suitable for the Data Safe Lock coding system, protecting the panel against electronic damage or interferences in network operation
- Labeling window including exchangeable labeling strips
- Individual labeling with A4 labeling sheets

Ordering Information

Description

PU

Part Number

010.2178



19" 1U Patch Panel 16xRJ45/u, Cat.6

- Supplied:
- 19" 1U 16-port patch panel, empty, unshielded
 - 16 Cat.6 connection modules, RJ45/u incl. dust covers
 - 19" mounting kit
 - 3 jumpering brackets
 - 4 labeling strips
 - Cable ties
 - Installation instructions

fully populated

1

R305888

090.2314

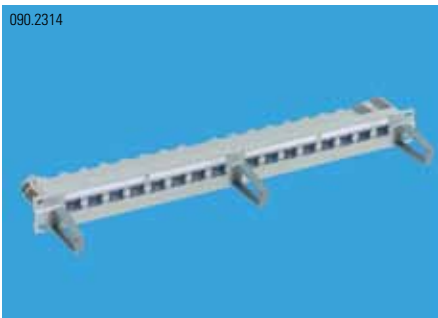

19" 1U Patch Panel 16xRJ45/u, Real10 Cat.6

- Supplied:
- 19" 1U 16-port patch panel, empty, unshielded
 - 16 Real10 Cat.6 connection modules, RJ45/u incl. WARP covers and dust covers
 - 19" mounting kit
 - 3 jumpering brackets
 - 4 labeling strips
 - Cable ties
 - Installation instructions

fully populated

1

R313086

Patch Panels
1U Patch Panels 16-Port



19" 1U Patch Panel 16xRJ45/s, Real10 Cat.6

- Supplied:
- 19" 1U 16-port patch panel, empty, shielded
 - 16 Real10 Cat.6 connection modules, RJ45/s incl. EMC covers and dust covers
 - 19" mounting kit
 - 3 jumpering brackets
 - 4 labeling strips
 - Cable ties
 - Installation instructions

fully populated 1 *R305887*



19" 1U Patch Panel 16xRJ45/u, Cat.5e

- Supplied:
- 19" 1U 16-port patch panel, empty, unshielded
 - 16 Cat.5e connection modules, RJ45/u incl. dust covers
 - 19" mounting kit
 - 3 jumpering brackets
 - 4 labeling strips
 - Cable ties
 - Installation instructions

fully populated 1 *R305886*



19" 1U Patch Panel 16xRJ45/s, Cat.5e

- Supplied:
- 19" 1U 16-port patch panel, empty, shielded
 - 16 Cat.5e connection modules, RJ45/s incl. EMC covers and dust covers
 - 19" mounting kit
 - 3 jumpering brackets
 - 4 labeling strips
 - Cable ties
 - Installation instructions

fully populated 1 *R305885*

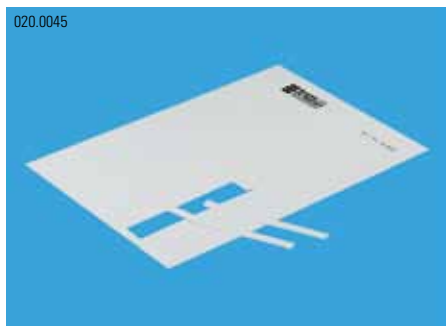

Labeling Sheet to 16-Port Patch Panel

- Suitable for laser printers
- Material: paper, white, perforated

- Supplied:
- A4 sheet with 48 strips (neutral)

1 *R306039*

i Get a free MS Word template at our website (www.rdm.com/universe) for fast and professional labeling

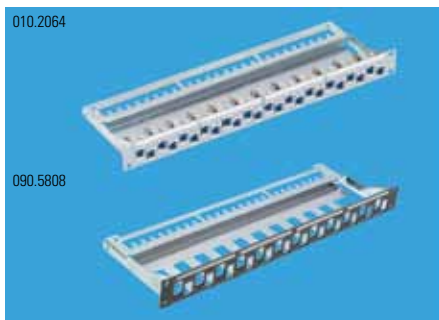

Features

- The high packing density results in a capacity of 24 shielded or unshielded RJ45 connections
- Every module is individually terminated
- The snap-in adapter is mechanically secured with a plastic wedge
- 8-color coding system with plastic wedges
- Integrated cable tie shelf
- Direct grounding concept via metal patch panel
- Protective conductor terminal optionally available

i ¹⁾Approval: UL

Ordering Information

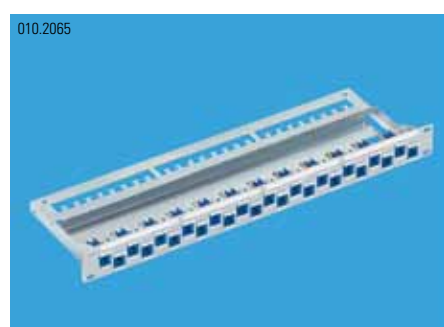

19" 1U Patch Panel 24xRJ45/u, Cat.6

- Supplied:
- 19" 1U 24-port metal patch panel, empty, integrated cable tie shelf
 - 24 Cat.6 connection modules, RJ45/u incl. dust covers
 - 19" mounting kit
 - 4 labeling strips
 - Cable ties
 - Installation instructions

fully populated ¹⁾ **Gray** 1 *R305117*
Black 1 *R321605*



19" 1U Patch Panel 24xRJ45/u, Real10 Cat.6

- Supplied:
- 19" 1U 24-port metal patch panel, empty, integrated cable tie shelf
 - 24 Real10 Cat.6 connection modules, RJ45/u incl. WARP covers and dust covers
 - 19" mounting kit
 - 4 labeling strips
 - Cable ties
 - Installation instructions

fully populated 1 *R313087*



19" 1U Patch Panel 24xRJ45/s, Real10 Cat.6

- Supplied:
- 1U 24-port metal patch panel, empty, integrated cable tie shelf
 - 24 Real10 Cat.6 connection modules, RJ45/s incl. EMC covers and dust covers
 - 19" mounting kit
 - 4 labeling strips
 - Cable ties
 - Installation instructions

fully populated ¹⁾ **Gray** 1 *R305120*
Black 1 *R313047*

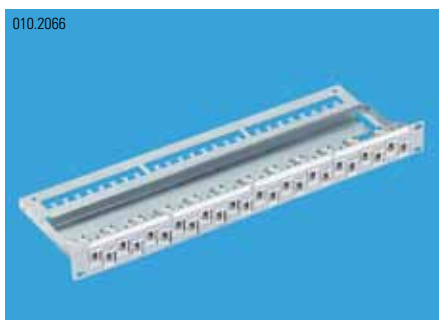

19" 1U Patch Panel 24xRJ45/u, Cat.5e

- Supplied:
- 19" 1U 24-port metal patch panel, empty, integrated cable tie shelf
 - 24 Cat.5e connection modules, RJ45/u incl. dust covers
 - 19" mounting kit
 - 4 labeling strips
 - Cable ties
 - Installation instructions

fully populated ¹⁾ **Gray** 1 *R305118*
Black 1 *R321604*

Patch Panels

1U Patch Panels 24-Port



19" 1U Patch Panel 24xRJ45/s, Cat.5e

Supplied:

- 19" 1U 24-port metal patch panel, empty, integrated cable tie shelf
- 24 Cat.5e connection modules, RJ45/s incl. EMC covers and dust cover
- 19" mounting kit
- 4 labeling strips
- Cable ties
- Installation instructions

fully populated ¹⁾

Gray

1

R305121

Black

1

R313048

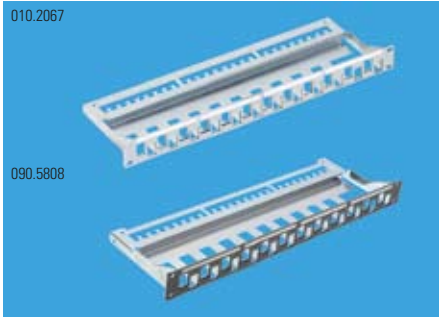

19" 1U Patch Panel 24-Port

- With a capacity for 24 snap-in connection modules shielded/unshielded or FO adapters snap-in frame

Supplied:

- 19" 1U 24-port metal patch panel, empty, integrated cable tie shelf
- 19" mounting kit
- 4 labeling strips
- Installation instructions

empty ¹⁾

Gray

1

R305119

Black

1

R511996

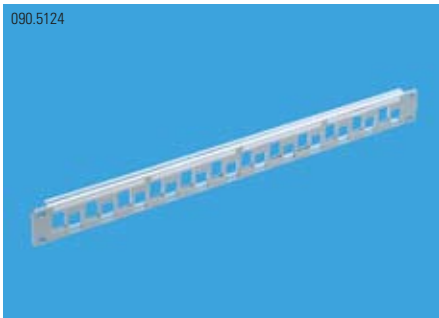

19" 1U Patch Panel 24Port BASIC empty

- With a capacity for 24 snap-in connection modules shielded/unshielded or FO adapters snap-in frame

Supplied:

- 19" 1U 24-port metal patch panel, empty
- 19" mounting kit
- 4 labeling strips
- Installation instructions

2

R503071

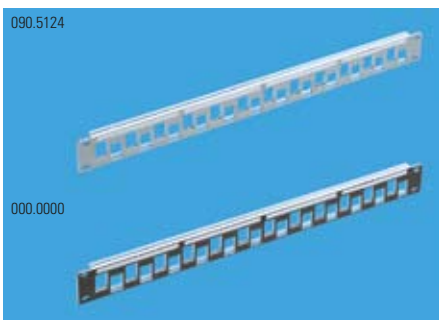

19" 1U Patch Panel BASIC Cat.6 24XRJ45/u

Supplied:

- 19" 1U 24-port metal patch panel, empty, integrated cable tie shelf
- 24 Cat.6 connection modules, RJ45/u incl. dust covers
- 19" mounting kit
- 4 labeling strips
- Cable ties
- Installation instructions

Gray

R503814

Black

R795206

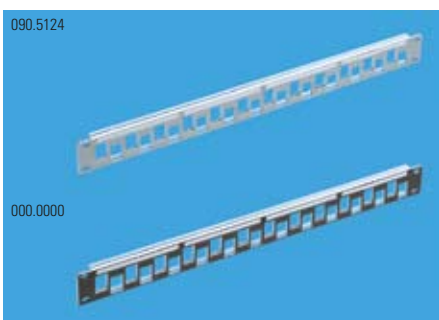

19" 1U Patch Panel BASIC Cat.5e 24xRJ45/u

Supplied:

- 19" 1U 24-port metal patch panel, empty, integrated cable tie shelf
- 24 Cat.5e connection modules, RJ45/u incl. dust covers
- 19" mounting kit
- 4 labeling strips
- Cable ties
- Installation instructions

Gray

R795139

Black

R795205



Ordering Information	Description	PU	Part Number
	<p>19" 1U Angled Patch Panel 24xRJ45/u, Cat.6 Supplied:</p> <ul style="list-style-type: none"> - 19" 1U 24-port angled, metal patch panel, empty, integrated cable tie shelf - 24 Cat.6 connection modules, RJ45/u incl. dust covers - 19" mounting kit - Labeling kit - Cable ties - Installation instructions <p>fully populated</p>	1	R500532
	<p>19" 1U Angled Patch Panel 24xRJ45/u, Real10 Cat.6 Supplied:</p> <ul style="list-style-type: none"> - 19" 1U 24-port angled, metal patch panel, empty, integrated cable tie shelf - 24 Real10 Cat.6 connection modules, RJ45/u incl. WARP covers and dust covers - 19" mounting kit - Labeling kit - Cable ties - Installation instructions <p>fully populated</p>	1	R500536
	<p>19" 1U Angled Patch Panel 24xRJ45/s, Real10 Cat.6 Supplied:</p> <ul style="list-style-type: none"> - 19" 1U 24-port angled, metal patch panel, empty, integrated cable tie shelf - 24 Real10 Cat.6 connection modules, RJ45/s incl. EMC covers and dust covers - 19" mounting kit - Labeling kit - Cable ties - Installation instructions <p>fully populated</p>	1	R500539
	<p>19" 1U Angled Patch Panel 24xRJ45/u, Cat.5e Supplied:</p> <ul style="list-style-type: none"> - 19" 1U 24-port angled, metal patch panel, empty, integrated cable tie shelf - 24 Cat.5e connection modules, RJ45/u incl. dust covers - 19" mounting kit - Labeling kit - Cable ties - Installation instructions <p>fully populated</p>	1	R500520

Patch Panels
1U Angled Patch Panels 24-Port



19" 1U Angled Patch Panel 24xRJ45/s, Cat.5e

- Supplied:
- 19" 1U 24-port angled, metal patch panel, empty, integrated cable tie shelf
 - 24 Cat.5e connection modules, RJ45/s incl. EMC covers and dust covers
 - 19" mounting kit
 - Labeling kit
 - Cable ties
 - Installation instructions

fully populated 1 *R500524*



19" 1U Angled Patch Panel 24-Port

- With a capacity of up to 24 snap-in connection modules shielded/unshielded
- Supplied:
- 19" 1U 24-port angled, metal patch panel, empty, integrated cable tie shelf
 - 19" mounting kit
 - Labeling kit
 - Installation instructions

empty 1 *R506796*
black 1 *R511997*

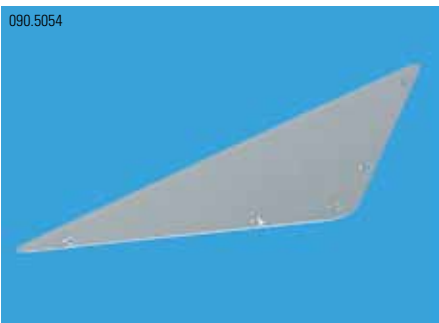

19" 1U Angled Patch Panel, Cover

- Protection against external mechanical factors
- Mounted and removed without tools

1 *R502913*



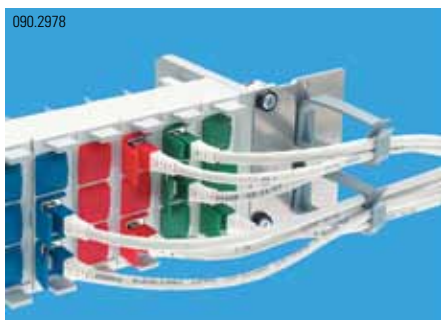

Features

- Thanks to their modular design the panels can be fitted with up to sixteen 3x1-port connection module holders or blind elements (max. 48xRJ45/u or RJ45/s ports)
- Highly installation and service friendly thanks to the optimized fastening system
- Shielded version includes complete integrated grounding system
- Suitable for the R&M Security Systems, Level 1-3
- Exchangeable labeling strips
- Integrated strain relief on connection module holder

Ordering Information

Description

PU

Part Number

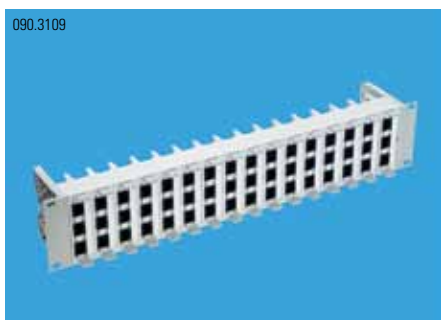

19" 2U Global Patch Panel 48xRJ45/u, Cat.6

- Supplied:
- 19" 2U Global patch panel/u
 - 16 connection module holders 2U Global/u
 - 48 Cat.6 connection modules, RJ45/u incl. dust covers
 - Labeling strips
 - 19" mounting kit
 - Cable ties
 - Installation instructions

fully populated

1

R505718

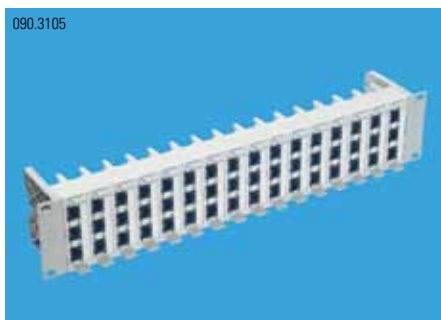

19" 2U Global Patch Panel 48xRJ45/u, Real10 Cat.6

- Supplied:
- 19" 2U Global patch panel/u
 - 16 connection module holders 2U Global/u
 - 48 Real10 Cat.6 connection modules, RJ45/u, incl. WARP covers and dust covers
 - Labeling strips
 - 19" mounting kit
 - Cable ties
 - Installation instructions

fully populated

1

R505720

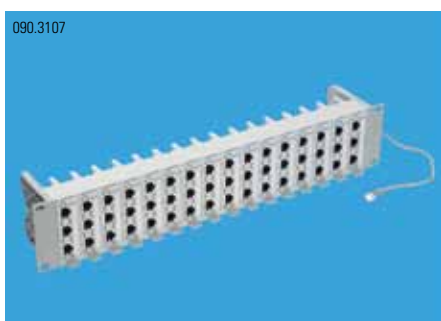

19" 2U Global Patch Panel 48xRJ45/s, Real10 Cat.6

- Supplied:
- 19" 2U Global patch panel/s
 - 16 connection module holders 2U Global/s
 - Grounding system
 - 48 Real10 Cat.6 connection modules, RJ45/s incl. EMC covers and dust covers
 - Labeling strips
 - 19" mounting kit
 - Cable ties
 - Installation instructions

fully populated

1

R505719

Patch Panels
2U Global Patch Panels
48-Port

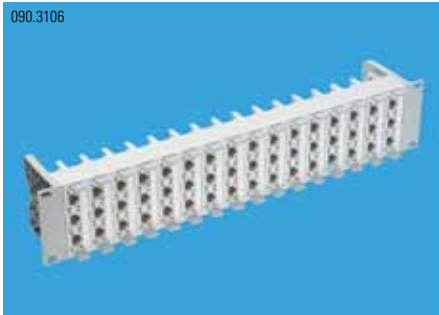

19" 2U Global Patch Panel 48xRJ45/u, Cat.5e

- Supplied:
- 19" 2U Global patch panel/u
 - 16 connection module holders 2U Global/u
 - 48 Cat.5e connection modules, RJ45/u incl. dust covers
 - Labeling strips
 - 19" mounting kit
 - Cable ties
 - Installation instructions

fully populated 1 *R505716*

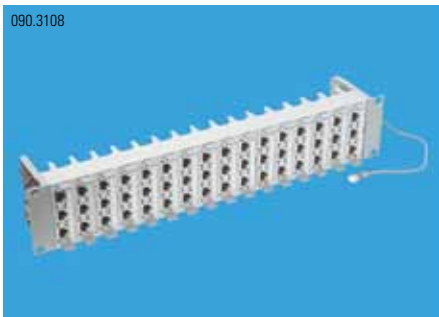

19" 2U Global Patch Panel 48xRJ45/s, Cat.5e

- Supplied:
- 19" 2U Global patch panel/s
 - 16 connection module holders 2U Global/s
 - Grounding system
 - 48 Cat.5e connection modules, RJ45/s incl. EMC covers and dust covers
 - Labeling strips
 - 19" mounting kit
 - Cable ties
 - Installation instructions

fully populated 1 *R505715*

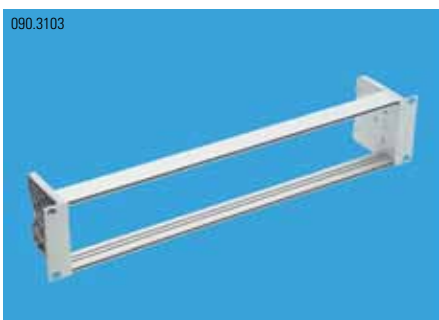

19" 2U Global Patch Panel 48-Port/u

- Holds up to sixteen 2U Global/u connection module holders or 2U Global blind covers
 - Max. capacity of 48 RJ45/u connection modules
- Supplied:
- 19" 2U Global patch panel/u
 - 19" mounting kit
 - Installation instructions

empty 1 *R503805*



19" 2U Global Patch Panel 48-Port/s

- Holds up to sixteen 2U Global/s connection module holders or 2U Global blind covers
 - Max. capacity of 48 RJ45/s connection modules
- Supplied:
- 19" 2U Global patch panel/s
 - Grounding system
 - 19" mounting kit
 - Installation instructions

empty 1 *R503806*

090.3104



Connection Module Holder 2U Global/u

– To be mounted into 19" 2U Global patch panels, unshielded

Holding capacity:

– 3 connection modules RJ45/u

Supplied:

– Connection module holder

– Labeling strip

1

R504610

090.3102



Connection Module Holder 2U Global/s

– To be mounted into 19" 2U Global patch panels, shielded.

Holding capacity:

– 3 connection modules RJ45/s

Supplied:

– Connection module holder

– Integrated grounding plate

– Labeling strip

1

R503813

020.0045



Labeling Sheet 2U Global

– Suitable for laser printers

– Material: paper, white, perforated

Supplied:

– A4 sheet with 75 strips (neutral)

1

R503380

090.3100



Blind Cover 2U Global

– For use with 19" 2U Global patch panels, shielded and unshielded

1

R316871

Patch Panels
3U Global Patch Panels
48- and 60-Port



Features

- Thanks to their modular design the panels can be fitted with up to fifteen 4x1-port connection module holders or blind elements (max. 60xRJ45/u, RJ45/s, SC-RJ or E-2000™-Compact ports)
- Highly installation and service friendly thanks to the snap-and-go fastening system
- Shielded version includes complete integrated grounding system
- Suitable for the Data Safe Lock coding system
- Coax can be integrated by means of adapter units
- Exchangeable labeling strips
- Cable tie shelf is a standard component

i ¹⁾ Approval: UL

Ordering Information

Description

PU

Part Number



19" 3U Global Patch Panel 48xRJ45/u, Cat.6

Supplied:

- 19" 3U Global patch panel/u incl. cable tie shelf
- 12 connection module holders Global/u
- 3 Global blind covers
- 48 Cat.6 connection modules, RJ45/u incl. dust covers
- Labeling strips
- 19" mounting kit
- Cable ties
- Installation instructions

partly populated

1

R302361



19" 3U Global Patch Panel 48xRJ45/u, Real10 Cat.6

Supplied:

- 19" 3U Global patch panel/u incl. cable tie shelf
- 12 connection module holders Global/u
- 3 Global blind covers
- 48 Real10 Cat.6 connection modules, RJ45/u incl. WARP covers and dust covers
- Labeling strips
- 19" mounting kit
- Cable ties
- Installation instructions

partly populated

1

R313088



19" 3U Global Patch Panel 48xRJ45/s, Real10 Cat.6

Supplied:

- 19" 3U Global patch panel/s incl. cable tie shelf
- 12 connection module holders Global/s
- 3 Global blind covers
- Grounding system
- 48 Real10 Cat.6 connection modules, RJ45/s incl. EMC covers and dust covers
- Labeling strips
- 19" mounting kit
- Cable ties
- Installation instructions

partly populated

1

R302360



010.2061

19" 3U Global Patch Panel 48xRJ45/u, Cat.5e

- Supplied:
- 19" 3U Global patch panel/u incl. cable tie shelf
 - 12 connection module holders Global/u
 - 3 Global blind covers
 - 48 Cat.5e connection modules, RJ45/u incl. dust covers
 - Labeling strips
 - 19" mounting kit
 - Cable ties
 - Installation instructions

partly populated

1

R35405



010.2059

19" 3U Global Patch Panel 48xRJ45/s, Cat.5e

- Supplied:
- 19" 3U Global patch panel/s incl. cable tie shelf
 - 12 connection module holders Global/s
 - 3 Global blind covers
 - Grounding system
 - 48 Cat.5e connection modules, RJ45/s incl. EMC covers and dust covers
 - Labeling strips
 - 19" mounting kit
 - Cable ties
 - Installation instructions

partly populated

1

R35404



010.2056

19" 3U Global Patch Panel 60xRJ45/u, Cat.6

- Supplied:
- 19" 3U Global patch panel/u incl. cable tie shelf
 - 15 connection module holders Global/u
 - 60 Cat.6 connection modules, RJ45/u incl. dust covers
 - Labeling strips
 - 19" mounting kit
 - Cable ties
 - Installation instructions

fully populated ¹⁾

1

R302363



090.2311

19" 3U Global Patch Panel 60xRJ45/u, Real10 Cat.6

- Supplied:
- 19" 3U Global patch panel/u incl. cable tie shelf
 - 15 connection module holders Global/u
 - 60 Real10 Cat.6 connection modules, RJ45/u, incl. WARP covers and dust covers
 - Labeling strips
 - 19" mounting kit
 - Cable ties
 - Installation instructions

fully populated

1

R313089

Patch Panels
3U Global Patch Panels
48- and 60-Port

010.2052

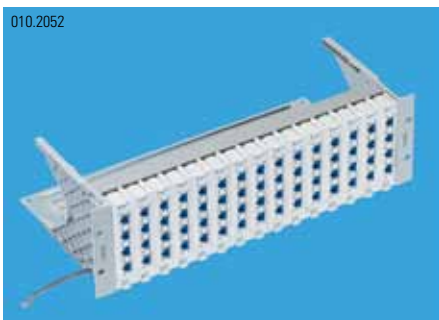

19" 3U Global Patch Panel 60xRJ45/s, Real10 Cat.6

- Supplied:
- 19" 3U Global patch panel/s incl. cable tie shelf
 - 15 connection module holders Global/s
 - Grounding system
 - 60 Real10 Cat.6 connection modules, RJ45/s incl. EMC covers and dust covers
 - Labeling strips
 - 19" mounting kit
 - Cable ties
 - Installation instructions

fully populated ¹⁾ 1 R302362

010.2060

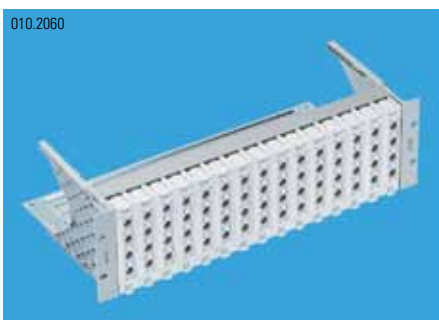

19" 3U Global Patch Panel 60xRJ45/u, Cat.5e

- Supplied:
- 19" 3U Global patch panel/u incl. cable tie shelf
 - 15 connection module holders Global/u
 - 60 Cat.5e connection modules, RJ45/u incl. dust covers
 - Labeling strips
 - 19" mounting kit
 - Cable ties
 - Installation instructions

fully populated ¹⁾ 1 R35407

010.2058



19" 3U Global Patch Panel 60xRJ45/s, Cat.5e

- Supplied:
- 19" 3U Global patch panel/s incl. cable tie shelf
 - 15 connection module holders Global/s
 - Grounding system
 - 60 Cat.5e connection modules, RJ45/s incl. EMC covers and dust covers
 - Labeling strips
 - 19" mounting kit
 - Cable ties
 - Installation instructions

fully populated ¹⁾ 1 R35406

010.2055



19" 3U Global Patch Panel 60-Port/u

- Holds up to fifteen Global/u connection module holders, Global blind covers or six Global adapter units
 - Max. capacity of 60 RJ45/u connection modules
- Supplied:
- 19" 3U Global patch panel/u incl. cable tie shelf
 - 19" mounting kit
 - Installation instructions

empty ¹⁾ 1 R35409

010.2054

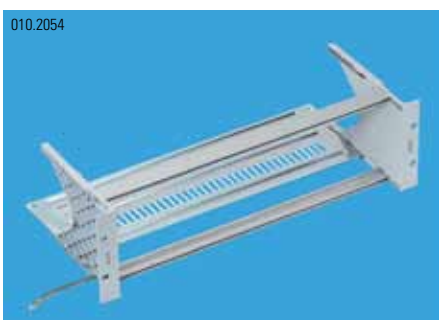

19" 3U Global Patch Panel 60-Port/s

- Holds up to fifteen Global/s connection module holders, Global blind covers or six Global adapter units
 - Max. capacity of 60 RJ45/s connection modules
- Supplied:
- 19" 3U Global patch panel/s incl. cable tie shelf
 - Grounding system
 - 19" mounting kit
 - Installation instructions

empty ¹⁾ 1 R35408



Connection Module Holder 3U Global/u
 – To be mounted into 19" 3U Global patch panels, unshielded
 Holding capacity:
 – 4 connection modules RJ45/u or
 – 4 SC-RJ or E-2000™-Compact adapters
 Supplied:
 – Connection module holder
 – Labeling strip
 – Installation instructions

1 GU ¹⁾ 1 R35403



Connection Module Holder 3U Global/s
 – To be mounted into 19" 3U Global patch panels, shielded
 Holding capacity:
 – 4 connection modules RJ45/s
 Supplied:
 – Connection module holder
 – Integrated grounding plate
 – Labeling strip
 – Installation instructions

1 GU ¹⁾ 1 R35402



Voice Adapter 3U Global
 – To be mounted into 19" 3U Global patch panels
 – Max. equipped with 5 voice adapters (150 ports)
 Holding capacity for 3 connection modules 10xRJ45
 Supplied:
 – Global Voice Adapter
 – 4 labeling strips

3x10-Port, 3 GU 1 R310400



Labeling Sheet Fiberliner / 3U Global Module Holder
 – For the labeling of front plates and 19" insertions
 – Dimensions: A4
 – Material: paper, white, perforated
 Supplied:
 – Fiberliner and 3U Global module holder labeling sheet (50 strips without logo)

1 R30871



Blind Cover 3U Global
 – For use with 19" 3U Global patch panels, shielded and unshielded

1 GU ¹⁾ 1 R35401

Patch Panels
Voice Panel, empty



Features

- 19" 1U voice panel with up to 50 RJ45/u ports
- Label holder with exchangeable labeling strips
- Cable guide for optimum pair routing
- Prepared for grounding connection

i ¹⁾ Approval: UL

Ordering Information

Description

PU

Part Number



19" 1U Patch Panel 50-Port, empty

- With a holding capacity of 5 connection modules
 10xRJ45/u

Supplied:

- 19" 1U (84HP) patch panel, powder-coated, gray
- 19" mounting kit
- 10 labeling strips
- Instruction manual

¹⁾

1

R35115

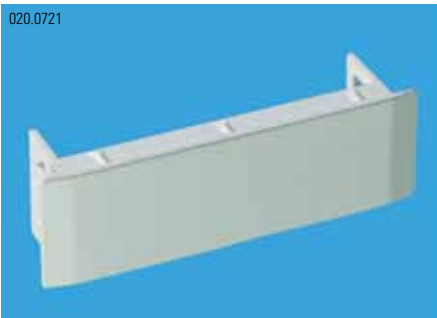

Blind Cover 1x10-Port, light gray

- To cover one unused port on the voice panel

¹⁾

1

R35117

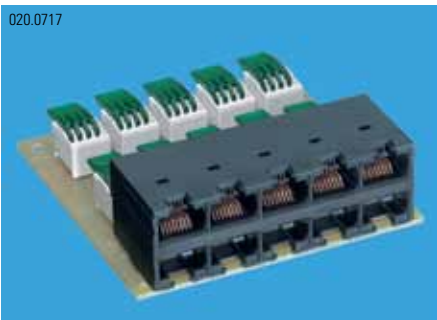

Connection Module 10xRJ45/u (4-5, 3-6)

- Connection module with 10 unshielded RJ45 ports
- Tool-free "Easy Lock" termination technique

¹⁾

10

R35116

i Wiring chart see specifications RJ45 voice connection modules

090.2325



i ¹⁾Approval: UL

Ordering Information

Description

PU

Part Number

090.2325



19" 1U Cable Management Plastic

- Plastic plate with four mounted jumpering brackets
- For a neat, horizontal routing of patch cords between patching fields
- The reinforced plastic plate and snap-in jumpering brackets provide additional stability and quick mounting

Supplied:

- 19" 1U plastic panel
- 4 plastic rings, gray
- 19" mounting kit

70 mm plastic ring ¹⁾

1

R306179

090.2324



19" 2U Cable Management Plastic

- Plastic plate with eight mounted jumpering brackets
- For a neat, horizontal routing of patch cords between patching fields
- The reinforced plastic plate and snap-in jumpering brackets provide additional stability and quick mounting

Supplied:

- 19" 2U plastic panel
- 8 plastic ring, gray
- 19" mounting kit

70 mm plastic ring ¹⁾

1

R306180

090.5062



19" 2U Cable Management Metal

- For a neat, horizontal routing of patch cords between patching fields
- Fast and tool-free assembly of jumpering brackets
- Easy insertion and removal of patch cords without damage to cable

Supplied:

- 19" 2U metal panel
- 8 metal rings
- 8" mounting screws
- 19" mounting kit

70 mm metal ring

1

R502281

90 mm metal ring

1

R502282

**Patch Panels
Accessories
19" Patch Panels**



19" 1U Cable Management Metal

- For a neat, horizontal routing of patch cords between patching fields
- Fast assembly of metal rings
- Easy insertion and removal of patch cords without damage to cable

70 mm metal ring	1	R502272
90 mm metal ring	1	R502280

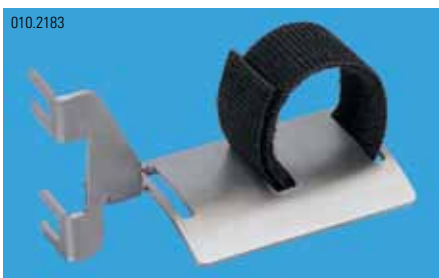

19" Lateral Radius Guard

- The radius guard guarantees compliance with admissible bending radii of copper and FO cables
- The guard is mounted to the front of 19" racks
- Color: medium gray (NCS 2503-B)

Supplied:

- Lateral radius guard, left
- Lateral radius guard, right
- Velcro fastening 19 x 400 mm

left and right	1	R306181
-----------------------	---	---------

i 19" mounting holes distance 1U



Universal Blind Cover

- To cover one unused connection module port
- Snaps into R&M Smartholes
- Color: light gray (NCS 1005-R80B)

light gray	100	R305766
pure white	100	R925719

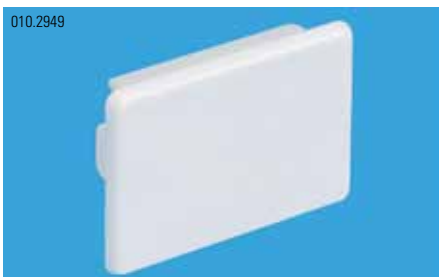

Snap-in Blind Cover

- For sheet metal cutouts of 15 x 19.5 mm in diameter and sheet thickness of 1.5 and 3 mm
- Color: light gray (NCS 1005-R80B)

light gray	10	R308708
-------------------	----	---------

i Also suitable for 19" 1U patch panels, 24xRJ45



Global Cable Management, 2-Ring, 70mm

- For vertical cable management with the Global 2U patch panel
- Fast installation - slides under Global 2U panel mounting screws
- Flexible - mounts on left or right outside of panel
- Saves space through higher port densities

plastic ring	1	R505851
metal ring	1	R503228



Global Cable Management, 3-Ring, 70mm

- For vertical cable management with the Global 3U patch panel
- Fast installation - slides under Global 3U panel mounting screws
- Flexible - mounts on left or right and on inside or outside of panel
- Saves space through higher port densities
- Width: 1.5 GU

plastic ring	1	R316247
metal ring	1	R503227



Features

- Cat.6A ISO allow transmission frequencies of 650 MHz
- 100 Ohm impedance
- Available in shielded and unshielded versions
- Compliant with Cat.6A ISO, Class EA (500 MHz) requirements: ISO/IEC 11801.2.1
- Compliant with Cat.6A ISO component standards IEC 60603-7-41 (unshielded) or 60603-7-51 (shielded)
- Connection 1:1

Ordering Information

Description

PU

Part Number



Patch Cord Cat.6A ISO, S/FTP, 4P, LSFRZH, RJ45/s-RJ45/s

- Cable identification: S/FTP
- Outer jacket: LSFRZH
- Conductor diameter copper strand: AWG26/7
- Screened in pairs: AL/foil
- Overall screen: copper braid
- Outer diameter: 6 mm

0.5 m	10	R509857
1.0 m	10	R509858
1.5 m	10	R509860
2.0 m	10	R509861
3.0 m	10	R509862
5.0 m	10	R509863
7.5 m	10	R509864
10.0 m	10	R509865
12.5 m	5	R509866
15.0 m	5	R509867
20.0 m	5	R509868



Patch Cord Cat.6A ISO, U/UTP, 4P, LSFRZH, RJ45/u-RJ45/u

- Cable identification: U/UTP
- Outer jacket: LSFRZH
- Conductor diameter copper strand: AWG26/7
- Screened in pairs: no
- Overall screen: no
- Outer diameter: 5.1 mm

0.5 m	10	R509869
1.0 m	10	R509870
1.5 m	10	R509871
2.0 m	10	R509872
3.0 m	10	R509873
5.0 m	10	R509874
7.5 m	10	R509875
10.0 m	10	R509876
12.5 m	5	R509877
15.0 m	5	R509878
20.0 m	5	R509879

Patch Cords
RJ45 Patch Cord Cat.6



Features

- **Cat.6 U/UTP suitable for transmission frequencies of 450 MHz**
- Real10 Cat.6 allow transmission frequencies of 650 MHz
- 100 Ohm impedance
- Available in shielded and unshielded versions
- Compliant with Cat.6, Class E (250 MHz) requirements: ISO/IEC 11801 2nd Edition
- Compliant with Cat.6 component standards IEC 60603-7-4 and 60603-7-5
- Connection 1:1

Ordering Information

Description

PU

Part Number



Patch Cord Real10 Cat.6, S/FTP, 4P, LSFRZH, RJ45/s-RJ45/s

- Cable identification: S/FTP
- Outer jacket: LSFRZH
- Conductor diameter copper strand: AWG26/7
- Screened in pairs: AL/foil
- Overall screen: copper braid
- Outer diameter: 6 mm

0.5 m	10	<i>R302331</i>
1.0 m	10	<i>R302332</i>
1.5 m	10	<i>R302333</i>
2.0 m	10	<i>R302334</i>
3.0 m	10	<i>R302335</i>
5.0 m	10	<i>R302336</i>
7.5 m	10	<i>R302337</i>
10.0 m	10	<i>R302338</i>
12.5 m	5	<i>R302339</i>
15.0 m	5	<i>R302340</i>
20.0 m	5	<i>R302418</i>



Patch Cord Cat.6, U/UTP, 4P, LSZH, RJ45/u-RJ45/u

- Cable identification: U/UTP
- Outer jacket: LSZH
- Conductor diameter copper strand: AWG26/7
- Screened in pairs: no
- Overall screen: no
- Outer diameter: 5.6 mm
- Color: Green (RAL 6029), Red (RAL 3031)
Yellow (RAL 1021), Blue (RAL 5015)

	PU	Gray	Green	Red	Yellow	Blue
0.5m	10	<i>R302309</i>	R317254	R321244	R314915	R317255
1.0m	10	<i>R302310</i>	R311941	R311928	R311935	R311938
1.5m	10	<i>R302311</i>	R317211	R315541	R314914	R317004
2.0m	10	<i>R302312</i>	R313970	R311932	R313866	R313969
3.0m	10	<i>R302313</i>	R311942	R311933	R311936	R311939
5.0m	10	<i>R302314</i>	R311943	R311934	R311937	R311940
7.5m	10	<i>R302315</i>	R321112	R316648	R800818	R316064
10.0m	10	<i>R302316</i>	R313872	R322650	R314762	R313869
12.5m	5	<i>R302317</i>	R801697	R801689	R801683	R801694
15.0m	5	<i>R302318</i>	R800910	R800816	R800819	R800822
20.0m	5	<i>R302319</i>	R317209	R801692	R801686	R317210

010.2038.1



Features

- Suitable for transmission frequencies of ≥ 200 MHz
- 100 Ohm impedance
- Available in shielded and unshielded versions
- Compliant with Cat.5e requirements of ISO/IEC 11801, EN 50173, EN 50168 and EIA/TIA 568A/B
- Meet test specifications of EIA/TIA 568A-B.2-1
- With R&M RJ45 connectors in acc. with IEC 60603-7 series
- Connection 1:1

Ordering Information

Description

PU

Part Number

010.2040



Patch Cord Cat.5e, U/UTP, 4P, PVC, RJ45/u-RJ45/u

- Cable identification: U/UTP
- Outer jacket: PVC
- Conductor diameter copper strand: AWG26/7
- Screened in pairs: no
- Overall screen: no
- Outer diameter: 5.1 mm

0.5 m	10	<i>R305014</i>
1.0 m	10	<i>R305015</i>
1.5 m	10	<i>R305019</i>
2.0 m	10	<i>R305020</i>
3.0 m	10	<i>R305021</i>
5.0 m	10	<i>R305022</i>
7.5 m	10	<i>R305023</i>
10.0 m	10	<i>R305024</i>
12.5 m	5	<i>R305025</i>
15.0 m	5	<i>R305026</i>
20.0 m	5	<i>R305027</i>

010.2040



Patch Cord Cat.5e, SF/UTP, 4P, LSFRZH, RJ45/s-RJ45/s

- Cable identification: SF/UTP
- Outer jacket: LSFRZH
- Conductor diameter copper strand: AWG26/7
- Screened in pairs: no
- Overall screen: copper braid + AL/foil
- Outer diameter: 5.5 mm

0.5 m	10	<i>R305039</i>
1.0 m	10	<i>R305040</i>
1.5 m	10	<i>R305041</i>
2.0 m	10	<i>R305042</i>
3.0 m	10	<i>R305043</i>
5.0 m	10	<i>R305044</i>
7.5 m	10	<i>R305045</i>
10.0 m	10	<i>R305046</i>
12.5 m	5	<i>R305047</i>
15.0 m	5	<i>R305048</i>
20.0 m	5	<i>R305049</i>

000.0000



Patch Cord Cat.5e Light, U/UTP, 4P, LSOH

- Cable identification: U/UTP
- Outer jacket: LSOH
- Conductor diameter copper strand: AWG26/7
- Screened in pairs: no
- Overall screen: no
- Outer diameter: 5.1 mm

1.0 m		R802907
1.5 m		R802906
2.0 m		R802310
3.0 m		R802296
5.0 m		R802309

Patch Cords
RJ45 Patch Cord Cat.6 / IP67



Patch Cord Real10 Cat.6, S/FTP, 4P, PUR, RJ45/s-RJ45/s

– Patch cords equipped with PUR jackets, ideal for use in harsh environments

2.5 m	5	R313633
5.0 m	5	R313634
7.5 m	5	R313635
10.0 m	5	R313632



Patch Cord Real10 Cat.6, S/FTP, 4P, PUR, RJ45/s-RJ45/s IP67

– Patch cords equipped with PUR jackets, ideal for use in harsh environments

2.5 m	5	R313637
5.0 m	5	R313638
7.5 m	5	R313639
10.0 m	5	R313636



Patch Cord Real10 Cat.6, S/FTP, 4P, PUR, RJ45/s-IP67-RJ45/s IP67

– Patch cords equipped with PUR jackets, ideal for use in harsh environments

2.5 m	5	R313641
5.0 m	5	R313642
7.5 m	5	R313643
10.0 m	5	R313640





The DRM adapter has been specifically developed to ensure convenient integration of data technology into 35 mm standard top-hat rails (DIN EN 50 022). It now offers universal applicability, saves space for its ideal format and is exceptionally easily mounted. The result is an effective and convincing support of the horizontal and vertical interation of system components.

Ordering Information	Description	PU	Part Number
	<p>DIN Rail Module DRM45, plastic</p> <ul style="list-style-type: none"> – DIN Rail Module DRM45 for one RJ45 port, SC-RJ or E-2000™ Compact – Color: light gray (RAL 7035) – Material: plastic (PC-GF10) <p>Supplied:</p> <ul style="list-style-type: none"> – DIN Rail Module DRM45 – Labeling strip – Instruction manual 	10	R314000
<p>i Suitable for RJ45 connection modules and fiberoptic connectors with support plates.</p>			
	<p>DIN Rail Module 2-port, metal</p> <ul style="list-style-type: none"> – DIN Rail Module DRM45 for two RJ45 port, SC-RJ or E-2000™ Compact <p>Supplied:</p> <ul style="list-style-type: none"> – 2-port DIN rail module – 2 module holders, white – Mounting clip fitting DIN top-hat rail 	1	R311182

Outlets
Compact Box 6x1-Port
Surface-Mounted



Features

- Suitable for surface mounted installations or as consolidation point in hollow floors
- Multifunctional unit
- Installation cables up to Cat.7 can be used
- Bottom part features integral strain relief lugs
- Cover features cable entry break-out points at the side and the back
- Accepts fiberoptic components
- Fire classification UL 94: V-0

i ¹⁾Approval: UL

Ordering Information

Description

PU

Part Number



Compact Housing

- Plastic: PC/ABS
- Supplied:
- Bottom part
- Top part
- 3 module holders 2xRJ45
- 6 cable ties
- 2 fastening screws

6x1-Port, pure white ¹⁾

1

R308971

i Suitable for RJ45 connection modules, connection module ISDN 2xRJ45 and fiberoptic connectors with support plates



Mini Surface Box

- Housing bottom part
- Housing top part
- Blind cover (when used as a 1-port outlet)
- Label strips, blank
- Installation manual

4x1-Port

1

R795111

4x1-Port with magnet

1

R795078



Mini Surface Box

- Plastic: ASA
- Supplied:
- Housing bottom part
- Housing top part
- Blind cover (when used as a 1-port outlet)
- Label strips, blank
- Installation manual

2x1-Port, pure white

10

R925728

2x1-Port with magnet

10

R304777



Mini Surface Mount Box

- Supplied:
- Housing bottom part
- Housing top part

1-Port, cream

1

R303901

1x1-Port with magnet

1

R795109

090.2086



Features

- Suitable for flush-mounted (FM) and duct-mounted (DM) installations
- For use with cover frames and duct covers of Ø 70 mm in diameter or 70x70 mm cutouts
- Suitable for backboxes and floorbox module holders of Ø 60 mm mounting tracks
- Recommended depth for backboxes and floorboxes ≥ 70 mm
- Plastic halogen-free in acc. with DIN/VDE 0472/815

Ordering Information

Description

PU

Part Number

090.2086



FM Global Outlet 88x88

- Plastic: PC/ABS
- Supplied:
 - Cover frame 88x88 mm
 - 2-part faceplate 60x60 mm
 - M3x12 screws
 - Blind cover (when used as a 1-port outlet)
 - Mounting plate, steel
 - Labeling strips, blank

2x1-Port, pure white

10

R310788

i Suitable for RJ45 connection modules, connection module ISDN 2xRJ45 and fiberoptic connectors with support plates

010.2902



FM Global Outlet 88x88

- Plastic: PC/ASA
- Supplied:
 - Cover frame 88x88 mm, pure white
 - 4-part faceplate 60x60 mm
 - M3x12 screws
 - Mounting plate, steel
 - Labeling strip, blank

4x1-Port, pure white

10

R305150

i Suitable for RJ45 special connection module

Outlets
503 Outlets
Flush-Mounted



Features

- Suitable for flush installations on walls, in ducts (metal and plastic) and in service poles
- For backboxes of 83.5 mm in horizontal mounting distance
- Plastic halogen-free in acc. with DIN/VDE 0472/815

Ordering Information

Description

PU

Part Number



503 Outlet 118x72

- Plastic: PC, PC/ABS
- Supplied:
 - Faceplate, type 503, holding 2x1-port
 - Hidden screws
 - Blind cover (when used as a 1-port outlet)
 - Label strips

2x1-Port, pure white

10

R510839

i Suitable for RJ45 connection modules, connection module ISDN 2xRJ45 and fiberoptic connectors with support plates



503 Outlet 118x72

- Plastic: PC, PC/ABS
- Supplied:
 - Faceplate, type 503, for RJ45 snap-in connection modules
 - Hidden screws
 - 2 blind covers (when used as a 2-port outlet)
 - Label strips

4x1-Port, pure white

10

R304275

i Suitable for RJ45 snap-in connection module



Features

- Suitable for flush and surface mount installations
- Ready for the R&M security system
- Including label window and exchangeable label strips
- Recommended depth for backboxes and floorboxes ≥ 70 mm
- Unibody design for convenience
- Prominent R&M logo

Ordering Information

Description

PU

Part Number



BS Faceplate 2x1 port, pure white

Supplied:

- Faceplate 86x86 mm for 2 RJ45 ports, including fastening screws
- Label strips
- 1 Blind cover (when used as a 1 port outlet)

2x1-Port, pure white

1

R795068



BS Faceplate 3x1 port, pure white

Supplied:

- Faceplate 86x86 mm for 2 RJ45 ports, including fastening screws
- 2 Label strips
- 1 Blind cover (when used as a 2 port outlet)

3x1-Port, pure white

1

R795069



BS Faceplate 4x1 port, pure white

Supplied:

- Faceplate 86x86 mm for 2 RJ45 ports, including fastening screws
- 2 Label strips

4x1-Port, pure white

1

R795070

Outlets
Flap Jack Module Holder (Type 6C)
Flush-Mounted



Features

- Suitable for flush and wall mounting
- Matching standard British cutout dimensions (6C)
- The horizontal design requires only half the space for RJ45 modules compared to other solutions
- The angled entry (45°) provides maximum cable protection
- Halogen-free in acc. with DIN/VDE 0472/815

Ordering Information

Description

PU

Part Number



Module Holder Flap Jack (Type 6C)

- Plastic: PC
- Supplied:
 - Flap Jack Module Holder
 - Instructions manual

1-Port, pure white

20

R303155

1-Port, jet black

20

R305702

i Suitable for RJ45/u special connection modules and Flap Jack connection modules



Mounting Plate Flap Jack 86x86

- Plastic: PC

2x1-Port, pure white

20

R303154



Features

- Suitable for flush installations and combined with a mounting frame also for surface mounting
- Wall plate dimensions 86x86 mm featuring a 50x50 mm cutout for 2 module holders
- The 2-port outlet can be turned into a 1-port outlet by using a blind cover
- Recommended depth for backboxes and floorboxes ≥ 70 mm

Ordering Information	Description	PU	Part Number
	<p>Shuttered "Fascia" 86x86 – 50x50 mm cutout for two mounting plates/blind cover – Plastic: ABS 2x1-Port, pure white</p>	20	R925895
	<p>Mounting Plate "Fascia" 25x50 – Plastic: ABS 1-Port, pure white</p> <p>i Suitable for RJ45 connection modules and fiberoptic connectors with support plates</p>	20	R925842
	<p>Blind Cover "Fascia" 25x50 – Plastic: ABS 1-Port, pure white</p>	40	R925897

Outlets
US Faceplates
Flush-Mounted



Features

- Suitable for flush mounting as well as duct-mounted installations (metal and plastic)
- Surface mounting compliant with the US mounting box
- Dimensions for backboxes and floorbox module holders of 83.5 mm (3.29 inch) mounting tracks
- Angled RJ45 entry for maximum cable protection
- Ready for the R&M security system
- Supplied with label windows plus exchangeable label strips
- Recommended depth for backboxes and floorboxes ≥ 70 mm

i ¹⁾Approval: UL

Ordering Information

Description

PU

Part Number



US Style Faceplate 72x117.5

- Plastic: PC/ABS
- Supplied:
 - US style faceplate
 - Hidden screws
 - 2xRJ45 module holder
 - Blind cover (when used as a 1-port outlet)
 - Label strips, blank

2x1-Port, pure white ¹⁾

10

R510838

i Suitable for RJ45 connection modules, connection module ISDN 2xRJ45 and fiberoptic connectors with support plates



US Style Faceplate 72x117.5

- Plastic: PC
- Supplied:
 - US style faceplate
 - Fastening screws
 - Hidden screws
 - 6xRJ45 module holder
 - 2 label strips, blank

6x1-Port, pure white ¹⁾

10

R925822

i Suitable for RJ45 connection modules and fiberoptic connectors with support plates



US Style Mounting Box

- Base plate: plastic, PC-GF10
- Housing: plastic, PC
- Supplied:
 - Base plate
 - Surface-mount housing

pure white ¹⁾

10

R925824



Features

- These mounting plates require a standard cutout of 45x45 mm
- Ready for the R&M security system
- Angled RJ45 entry for maximum cable protection
- Recommended depth for backboxes and floorboxes ≥ 70 mm

Ordering Information

Description

PU

Part Number



Mounting Plate 22.5x45

Supplied:

- Faceplate 22.5x45 mm, flat
- Module holder for one RJ45 connection module

1-Port, white

10

R307835

1-Port, black

10

R307837



Mounting Plate 45x45

– Plastic: PC/ABS

Supplied:

- Double mounting plate 45x45 mm, flat, for holding two RJ45 connection modules
- Blind cover (when used as 1-port outlet)
- Label strips, blank

2x1-Port, pure white

10

R313330

2x1-Port, jet black

10

R313333

i Suitable for RJ45 connection modules and FO connectors with support plates



Angled Mounting Plate 45x45

– Plastic: PC/ABS

Supplied:

- Double mounting plate 45x45mm with angled exit, for holding two RJ45 connection modules
- Blind cover (when used as 1-port outlet)
- Label strips, blank

2x1-Port, pure white

10

R313332

2x1-Port, jet black

10

R313331

i Suitable for RJ45 connection modules and FO connectors with support plates

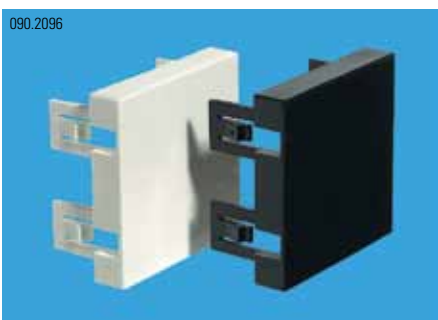

Faceplate Blind 45x45

– Dimensions: 45x45 mm

white

1

R307960

black

1

R309170

Outlets
Outlets IP54
Surface- and Flush-Mounted



Operational scope:

- Suitable for surface and flush mounting in wet locations
- Water and dust protected in accordance with IP 54 (QuineI)
- Temperature range of -25°C to +80°C (-40°C to +80°C for storage and transport)
- Steam, hot water, oils
- Condensation
- Salty water environment
- Dust in any form
- Air pollution in general (non acid)

Ordering Information

Description

PU

Part Number



010.2266

FM Connection Box Splash Line IP54, 87x87

- Color: pure white (RAL 9010)
- Supplied:
 - Foam-rubber padded mounting frame
 - Cover frame
 - Round central plate including O-ring and fastening screws
 - Label strips
 - Label window
 - Instruction manual

1x1-Port, white

1

R307037

2x1-Port, white

1

R307036



010.2264

SM Connection Box Splash Line IP54, 87x87

- Supplied:
 - Bottom part surface-mounted housing
 - Foam-rubber padded mounting frame
 - Cover frame
 - Round central plate including O-ring and fastening screws
 - Label strips
 - Label window
 - Instruction manual

1x1-Port, white

1

R307038

2x1-Port, white

1

R307039

i Also mounted on DIN top-hat rail.
 Cable glands M20x1.5 (min. IP55) not included.



010.2134

Splash Cap IP54

- Offering dust protection and color coding to data outlets and patch panels
- The cap with its rubber seal provide protection class IP54

- Supplied:
 - Splash cap
 - Rubber seal
 - Installation manual

white

10

R306063

blue

10

R306058

red

10

R306062

yellow

10

R306060

green

10

R306061

010.2127



Splash Sleeve IP54

- Elastic, transparent rubber sleeve suitable for all RJ45 patch cords
- Together the Splash sleeve and the Splash cap offer protection class IP54

transparent

10

R320385

010.2864



Adapter Collar

- Matching backbox adapter for FM Splash outlets, 87x87 mm
- Featuring a particularly spacious interior

for FM Splash Outlet

10

R309022

010.2140



Splash Mounting Tool

- Sleeve expander for fitting Splash sleeves onto patch cords
- The expander features a mechanical stop so as not to overstretch the sleeves

3-Prong Sleeve Expander

1

R306057



**Outlets
Accessories**



Block Module Holder
- 1x1 port for JIS frame

10 R795107



010.0934

Blind Cover Universal

- For covering one unused port on a connection module
- Snapped-on instead of a coding system

pure white

100 R925719



090.2099

Adapter No. 1

- For use with different third-party faceplates
- Can be fitted with the R&M special connection module

20 R310694



000.0000

Module Holder for Third-Party Faceplate, with R&M Logo

- For use with clipsal faceplates
- Compatible with Cat.5e, Cat.6 and Cat 6A ISO connection modules with support plate
- R&M logo

100 R795209



Features

- Flexible workplace accessing
- Double cable strain relief provided by FLEXkanal holder
- Accepted power outlets German, Swiss, Belgian/French and British, Italian, US, Chinese, Australian
- Accepted data communication components: mounting plate for connection module RJ45, SC-RJ and E-2000™ Compact
- Accepted multimedia components: Chinch, VGA 15-pin, USB"A"
- Mounting plate features R&M Smartholes for the R&M security system
- All boxes come equipped, wired and connector-ready on request

i Refer to Pg 42

Ordering Information

Description

PU

Part Number

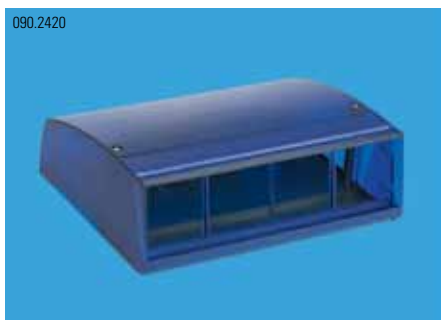

090.2420

DESKbox empty, 4x45x45

- All installations with 45x45 mm installation track for data and power connections
- Supplied:
 - Box, empty, ready to be fitted with 4 devices (45x45 mm)
 - 4 plastic base units
 - Cable entry at the back
 - FLEXkanal holder featuring double strain relief

clear (transparent)	1	R307791
blue (transparent)	1	R307792
green (transparent)	1	R307793
orange (transparent)	1	R307794
anthracite	1	R309571

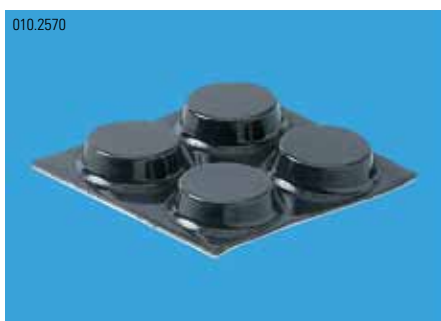

010.2570

Plastic Base, adhesive

- For a firm grip of the boxes on smooth surfaces

qty 4	1	R307786
--------------	---	---------



010.2569

3M Dual Lock

- For fastening the boxes - on or underneath the work desk

qty 2, 25x20 mm	1	R307785
------------------------	---	---------



Power Module 45 x 45

British power socket for DESKbox	10	R101872
Germany power socket for DESKbox	10	R101915
China power socket for DESKbox	10	R101916
Euro US power socket for DESKbox	10	R101917



Security level 1 (visual color coding)

The visual color coding supports correct connecting of the respective copper and fiberoptic cables. The color coding clips are easily clipped to connection cables and ports (outlets, patch panels). When applications are reassigned within the network, the color coding elements are simply moved or replaced, no tools needed.

 ¹⁾ Approval: UL

Ordering Information

Description

PU

Part Number



Hinged Dust Cover

– Dust cover and color coding for RJ45 outlets and patch panels
– Fitting R&M Smartholes

anthracite ¹⁾	10	R305685
blue ¹⁾	10	R305686
brown ¹⁾	10	R305687
yellow ¹⁾	10	R305688
gray ¹⁾	10	R305689
green ¹⁾	10	R305690
red ¹⁾	10	R305691
violet ¹⁾	10	R305692
white ¹⁾	10	R305693



Color Coding

– Color coding for RJ45 patch cords and consolidation point patch cords.

anthracite ¹⁾	20	R302342
blue ¹⁾	20	R302343
brown ¹⁾	20	R302344
yellow ¹⁾	20	R302345
gray ¹⁾	20	R302347
green ¹⁾	20	R302348
red ¹⁾	20	R302349
violet ¹⁾	20	R302420



Easy Latch

– Easy Latch for RJ45 patch cords and consolidation point patch cords

anthracite	20	R317100
blue	20	R317094
brown	20	R317095
yellow	20	R317096
gray	20	R317097
green	20	R317098
red	20	R317099
violet	20	R317093



010.1713

Snap-in Coding Clip

– Color coding clip for snap-in adapters and the multimedia outlet

anthracite	10	R302151
blue	10	R302152
brown	10	R302153
green	10	R302154
red	10	R302155
violet	10	R302156
white	10	R302157
yellow	10	R302158

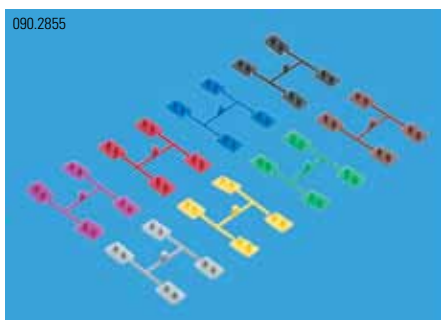

090.2855

Color Coding RMS45

– Matching the RMS45 insert and RMS45 plugs, 1- and 2-pair
– Four color codings per block

anthracite	10	R319031
blue	10	R319024
brown	10	R319025
yellow	10	R319026
gray	10	R319027
green	10	R319028
red	10	R319029
violet	10	R319030

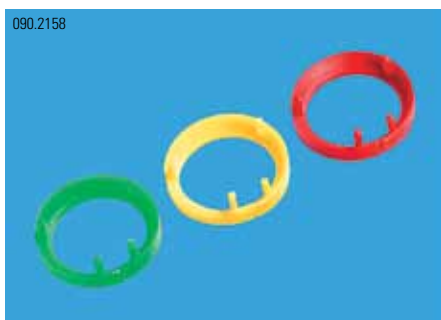

090.2158

FM45 Color Coding Clip

– Color coding for connector FM45

blue ¹⁾	10	R311580
brown ¹⁾	10	R311569
yellow ¹⁾	10	R311579
gray ¹⁾	10	R311570
green ¹⁾	10	R311577
red ¹⁾	10	R311571
violet ¹⁾	10	R311575
anthracite ¹⁾	10	R311561



090.2042

Plug Reduction Frame RJ45 onto RJ11/RJ12

– Prevents RJ45 plugs (data) being plugged into RJ45 outlets defined as telephone sockets (RJ11 connectors) by mistake
– Compatible with R&M RJ45 modules

	10	R310835
--	----	---------

**Security System
Security Level 3**

010.3116



Security level 3 (mechanical plug-out / plug-in protection)

These products introduce future-proof security to network connections. Only trained and authorized staff can release copper or fiberoptic connections. Copper and FO connectors can also be lock-protected for authorized plug-in only.

i ¹⁾ Approval: UL

Ordering Information

Description

PU

Part Number

010.1880.1



Plug Guard

– RJ45 connection protection for outlets and patch panels

– Fitting R&M Smartholes

Supplied:

– Plug Guard

– 1 key per packing unit

green ¹⁾

20

R304825

white ¹⁾

20

R304827

red ¹⁾

20

R304826

010.2289



Jack Guard

– RJ45 plug-in protection for outlets and patch panels

– Fits Plug Guard

Supplied:

– Jack Guard

– 1 key per packing unit

20

R307199

090.2289



Key Plug Guard / Fiber Guard

– Key and key-ring to Plug Guard and Fiber Guard

1

R304828

010.1910.1



Safe Clip

– Locking element for RJ45 patch cords (R&M standard patch cords), protecting connections from being unplugged by mistakes.

¹⁾

20

R304807

010.3573

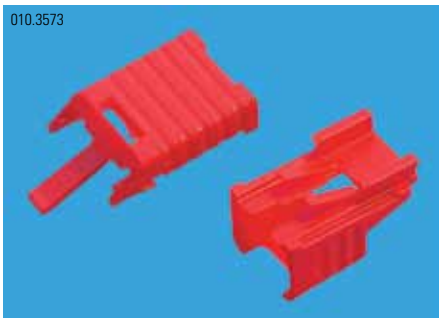

Patch Guard RJ45

– Lockable plug-out protection for RJ45 connecting cables (R&M standard patch cables)

Supplied:

- Patch Guard, top part
- Patch Guard, bottom part
- 1 key per packing unit

20

R313814

090.2288



Key Patch Guard RJ45

– This Patch Guard key releases locked RJ45 connectors

Supplied:

- Key plus keyring

1

R313815

000.0000



Port Guard

– RJ45 Connection protection for outlets and patch

Supplied:

- 20 port guard with 1 key

20

R510854



SECURITY

GET MORE. Products and services for maximum stability and availability of your networks. Thanks to guaranteed Swiss quality.



R&M
Convincing cabling solutions

Cable Routing FLEXkanal

010.2730



Features

- For an organized and protected cable routing up to your desk
- For connecting deskboxes with cable ducts or floor connection boxes
- Integral cable organization in two channels

Capacity per channel:

- 2 cables of Ø-8.5 mm or 3 cables of Ø-7.5 mm or 4 cables of Ø-7.0 mm or 5 cables of Ø-6.0 mm

Ordering Information

Description

PU

Part Number

010.2615



FLEXkanal, extended 1 m

- For an organized and protected cable routing up to your desk, connecting deskboxes with cable ducts or floor connection boxes
- Integral cable organization in two channels
- Length 1 m in extended form

FLEXkanal, black gray RAL 7021

1

R302724

FLEXkanal, light gray RAL 7035

1

R307688

FLEXkanal, white RAL 9010

1

R307689

FLEXkanal, red RAL 3020

1

R307976

FLEXkanal, ultramarine RAL 5002

1

R307690

FLEXkanal, yellow RAL 1023

1

R307831

FLEXkanal, yellow/black gray RAL 1023/7021

1

R307830

010.2613

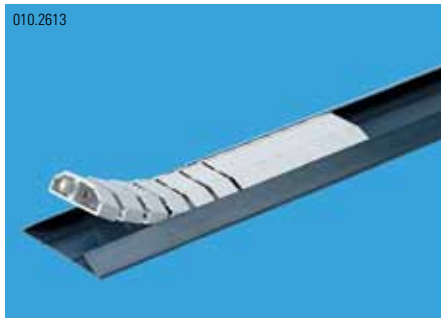

FLEXkanal Floor Rail

- Fix the rail on the floor, press the FLEXkanal into it
- The angled sides minimize the tripping risk

1 m, anthracite RAL 7016

10

R307700

2 m, anthracite RAL 7016

10

R307701

010.2608

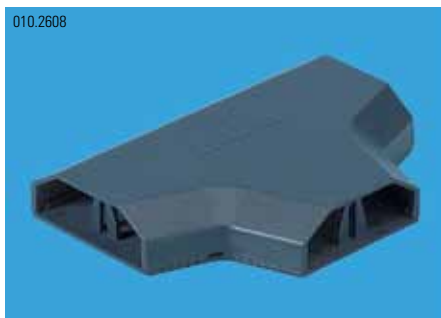

FLEXkanal T-piece

- T-piece junction for workplace branching
- Supplied:

- FLEXkanal floor T-piece
- FLEXkanal T-piece cover

anthracite RAL 7016

10

R307703

with cable passage

R307699

090.2194



Cable Passage Ø 95 with FLEXkanal Link, anthracite

- Cable grommet for use in raised floor featuring FLEXkanal link
- Color: anthracite (RAL 7016)
- Required-Ø: 95 mm

1

R312767

010.2792



Features

- Compact design (SFF)
- Outstanding optical performance
- Twice as many terminations as regular connector types
- Duplex adapter fits in SC Simplex cutout



Ceramic = zirconia ceramic alignment sleeve
PhBr = phosphor bronze alignment sleeve

Ordering Information

Description

PU

Part Number

000.0000



Adapter LC-Duplex

Supplied:

- Adapter LC-Duplex
- 2 Philips head screws M2 x 8, blue galvanized
- 2 mounted hexagonal nuts M2, blue galvanized

PC, blue, ceramic SM, C

12

R308894

PC, blue, PhBr SM, D

12

R308895

PC, beige, PhBr MM, N

12

R308896

090.5193



Adapter LC-Duplex PC (For Security)

Supplied:

- Adapter LC-Duplex with semi-transparent dust caps
- Color coding: adapter / frame - frame
- M2 nuts pre-mounted

blue/blue-non, ceramic SM, C

12

R500220

blue/blue-non, PhBr SM, D

12

R500170

beige/beige-non, PhBr, MM, N

12

R500078

090.2875



Universal Adapter LC-Duplex

– Universal adapter equipped with adapter

SM, ceramic, blue, D

1

R318738

MM, PhBr, beige, M

1

R318739

Connection Systems
Adapters SC
SC, SC-Duplex, SC-RJ



Features

- Injection-molded PBT housing, UL 94 V-0 (flammability index)
- Split ceramic sleeve/phosphor bronze sleeve
- 500 mating cycles

i Ceramic = zirconia ceramic alignment sleeve
 PhBr = phosphor bronze alignment sleeve

Ordering Information

Description

PU

Part Number



Adapter SC-Duplex

Supplied:

- SC-Duplex adapter
- 2 Philips head screws M2 x 8, blue galvanized
- 2 mounted hexagonal nuts M2, blue galvanized

PC, blue, ceramic SM, C

12

R30805

PC, blue, PhBr SM, D

12

R306879

PC, beige, PhBr MM, N

12

R303561



Adapter SC-RJ

Supplied:

- SC-RJ adapter flangeless with semi-transparent dust caps
- Support plate
- Installation instructions

Adapter SC-RJ PC, blue, PhBr SM, D, support plate

12

R318269

PC, black, PhBr MM, N, support plate

12

R308459

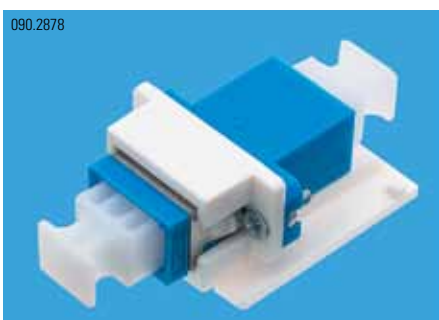

Universal Adapter SC

– Universal adapter equipped with adapter

SM, ceramic, blue, D

1

R318736

MM, PhBr, beige, M

1

R318737

090.2434



Features

- Short installation time
- Compatible with customary LC connectors
- For multimode and singlemode applications
- For 0.9 mm to 3 mm cables

i The mechanical crimp connectors type ST, SC and LC allow a simple and fast field termination of single fiber cables.

Ordering Information

Ordering Information	Description	PU	Part Number
<p>090.2434</p>	Mechanical Crimp Connectors LC – LC field-terminated – The ferrule is pre-assembled with a fiber and a mechanical splice connection – Field installable without polishing		
	PC, blue, G.652.D, field-terminated	10	R310561
	PC, turquoise, OM3, field-terminated	10	R314447
	PC, black, OM2, field-terminated	10	R310559
	PC, beige, OM1, field-terminated	10	R310560
<p>090.2435</p>	Mechanical Crimp Connectors SC – SC field-terminated – The ferrule is pre-assembled with a fiber and a mechanical splice connection – Field installable without polishing		
	PC, blue, G.652.D, field-terminated	10	R305178
	PC, turquoise, OM3, field-terminated	10	R314448
	PC, black, OM2, field-terminated	10	R305179
	PC, beige, OM1, field-terminated	10	R305180
<p>030.1523</p>	Mechanical Crimp Connectors ST – ST field-terminated – The ferrule is pre-assembled with a fiber and a mechanical splice connection – Field installable without polishing		
	PC, blue, G.652.D, field-terminated	10	R305181
	PC, turquoise, OM3, field-terminated	10	R314449
	PC, black, OM2, field-terminated	10	R305182
	PC, beige, OM1, field-terminated	10	R305183

Connection Systems
Connector LC/SC/ST Field termination

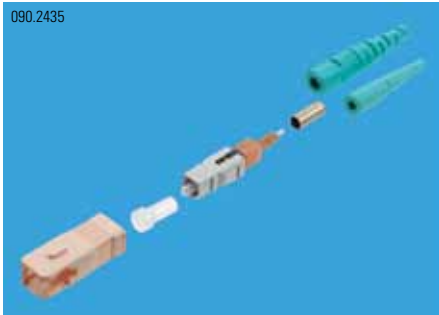

Features

- Short installation time
- Compatible with customary SC connectors
- For multimode and singlemode applications
- For 0.9 mm to 3 mm cables

i The mechanical crimp connectors type ST, SC and LC allow a simple and fast field termination of single fiber cables.

Ordering Information

Description

PU

Part Number

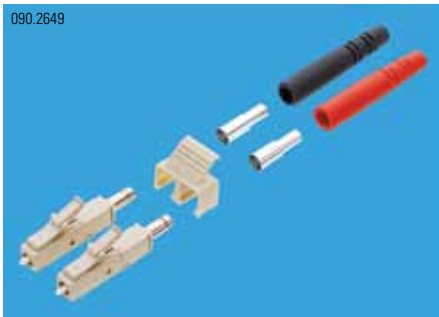

Connector Kit LC

- LC field-terminated
- Injection-molded PEI housing, UL94 V-0 (flammability index)
- Field polish

PC, SM, blue, C, 126, 0.9 mm tube, blue	50	R506971
PC, SM, blue, C, 126, 2.1 mm cable, blue	50	R317149
PC, MM, beige, M, 127, 0.9 mm tube, beige	50	R506989
PC, MM, beige, M, 127, 2.1 mm cable, black	50	R316612

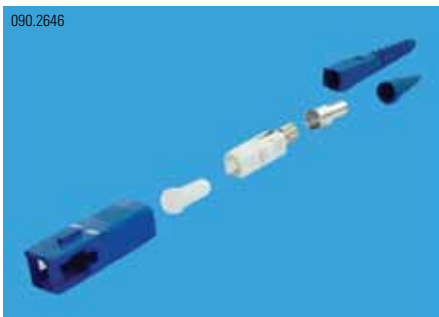

Connector Kit SC

- SC field-terminated
- Injection-molded PEI housing, UL94 V-0 (flammability index)
- Field polish

PC, SM, blue, C, 125.5, 0.9 + 2.8 mm tube blue	10	R795103
PC, MM, beige, M, 127, 0.9 + 2.8 mm tube beige	10	R795123



Connector Kit ST

- ST field-terminated
- Injection-molded PEI housing, UL94 V-0 (flammability index)
- Field polish

PC, SM, M, 126, 2.1 mm cable, blue	50	R317153
PC, SM, M, 126, 2.8 mm cable, blue	50	R317151
PC, MM, M, 127, 0.9 mm tube, black	50	R506993
PC, MM, M, 127, 2.1 mm cable, black	50	R316618



The SC-RJ IP67 connector developed by R&M is a new fiber-optic connector of protection class IP67 that unites a unique range of features, and supports applications of up to 10 Gigabit Ethernet. The connector system is a first of its kind for industrial applications, designed in Small Form Factor and featuring 2.5 mm ferrule technology, a safety system and double color coding.

i Available on request:
IP67 Patch cords OM1, OM2, OM3 and OS1 of different lengths

Ordering Information	Description	PU	Part Number
<p>090.2109</p>	<p>Patch Cord SC-RJ IP67 PC - SC-RJ IP67 PC – Both sides fitted with SC-RJ IP67 PC plug – Plug color: gray – Fiber: MMG50/125 (OM2) – Cable: Ø 6.0 mm, black (PUR) – Pulling Force: 800 N</p> <p>OM2, M/4, 20 m</p>	1	R318666
<p>090.2124</p>	<p>Mounting Frame IP67 Interbus, plastic – Compatible with SC-RJ and RJ45 one-channel module Supplied: – Mounting frame – Gasket – 4 screws M3x11.5 – 4 screw KA30x10</p>	1	R309588
<p>010.3208</p>	<p>Protective Cover IP67 Interbus – Cover protecting the contact insert in the IP67 adapter frame Interbus</p>	5	R309589

FO Patch Cords / Pigtailed MM



FO patch cords are used to interconnect active network components or do the connections on the patch panel.

Features

- Available in wide range of lengths
- Duplex patch cord
- LSZH cable jacket
- Typical attenuation:
< 0.30 dB for both SM/MM
- other connector type & simplex configuration available upon request

FO Duplex Patch Cord

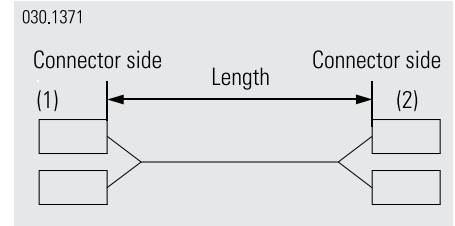
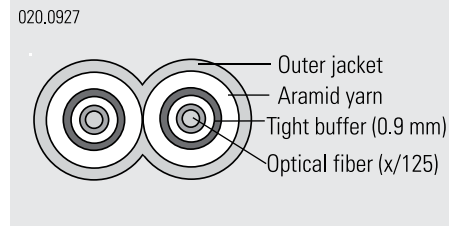
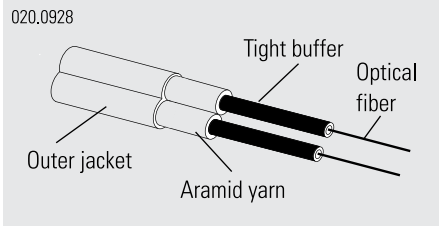

Connector side		Connector side		010.1254.2				010.2310	
		1	2	ST	50/125 (OM2)	50/125 (OM3)	9/125 OS1 (PC)	SC Duplex 62.5/125 (OM1)	50/125 (OM2)
ST	010.1254.2		1 m	R30640	R30635	R800374	R800308	R303975	R303970
			2 m	R30641	R30636	R323040	R320153	R303976	R303971
			3 m	R30642	R30637	R323041	R800309	R303977	R303972
			5 m	R30644	R30639	R323042	R800310	R303979	R303974
			10 m	R800352	R800353	R800354	R800311	R800355	R800356
SC Duplex	010.2310		1 m	R303975	R303970	R800299	R800303	R303985	R303980
			2 m	R303976	R303971	R800032	R800304	R303986	R303981
			3 m	R303977	R303972	R800300	R800305	R303987	R303982
			5 m	R303979	R303974	R800301	R800306	R303989	R303984
			10 m	R800355	R800356	R800302	R800307	R800357	R800358
SC-RJ	090.2056		1 m	R30591	R300131	R800312	R800317	R300126	R300121
			2 m	R30592	R300132	R800313	R800318	R300127	R300122
			3 m	R30593	R300133	R800314	R800319	R300128	R300123
			5 m	R30595	R300135	R800315	R800320	R300130	R300125
			10 m	R800360	R800361	R800316	R800321	R800362	R800363
LC	010.2804		1 m	R800253	R800289	R800292	R800294	R800377	R310290
			2 m	R800285	R312986	R800023	R800295	R308935	R308947
			3 m	R800286	R313136	R800024	R800296	R308936	R308948
			5 m	R800287	R800290	R800025	R800297	R308937	R308949
			10 m	R800288	R800291	R800293	R800298	R318169	R800366
Pigtail		2.5 m	R307300	R307299	R307387	R313152	R301462	R301461	

Ordering Information

Description

Packing Unit

Part Number

010.2983/010.2982



Color Clip, coding for SC-RJ patch cable

grey	12	R310145
blue	12	R310143
orange	12	R310148
yellow	12	R310142
turquoise	12	R310146
green	12	R310141
red	12	R310144
violet	12	R310147
Coding Frame	12	R310216

		090.2056 SC-RJ 62.5/125 (OM1) 50/125 (OM2) 50/125 (OM3) 9/125 OS1 (PC)				 010.2804 LC 62.5/125 (OM1) 50/125 (OM2) 50/125 (OM3) 9/125 OS1 (PC)			
R800299	R800303	R30591	R300131	R800312	R800317	R800253	R800289	R800292	R800294
R800032	R800304	R30592	R300132	R800313	R800318	R800285	R312986	R800023	R800295
R800300	R800305	R30593	R300133	R800314	R800319	R800286	R313136	R800024	R800296
R800301	R800306	R30595	R300135	R800315	R800320	R800287	R800290	R800025	R800297
R800302	R800307	R800360	R800361	R800316	R800321	R800288	R800291	R800293	R800298
R800375	R313027	R300126	R300121	R800322	R800331	R800377	R310290	R323059	R800378
R323074	R303343	R300127	R300122	R800324	R800332	R308935	R308947	R323060	R308913
R323045	R303344	R300128	R300123	R800325	R800333	R308936	R308948	<i>R323061</i>	<i>R308914</i>
R323046	R303346	R300130	R300125	R800326	R800334	R308937	R308949	R323062	R308915
R800359	R313414	R800362	R800363	R800327	R800335	R318169	R800366	R800121	R313410
R800322	R800331	R30581	R300116	R800336	R800341	R800379	R310289	R800238	R800346
R800324	R800332	R30582	R300117	R800337	R800342	R308932	R308944	R800672	R800347
R800325	R800333	R30583	R300118	R800338	R800343	R308933	R308945	R800112	R800348
R800326	R800334	R30585	R300120	R800339	R800344	R308934	R308946	R803255	R800349
R800327	R800335		R800365	R800340	R800345	R800370	R800371	R800114	R800350
R323059	R800378	R800379	R310289	R800238	R800346	R310296	R310292	R323063	R310284
R323060	R308913	R308932	R308944	R800672	R800347	R308926	R308938	R323064	R308903
<i>R323061</i>	<i>R308914</i>	R308933	R308945	R800112	R800348	R308927	R308939	<i>R323065</i>	<i>R308904</i>
R323062	R308915	R308934	R308946	R803255	R800349	R308928	R308940	<i>R323066</i>	R308905
R800121	R313410	R800370	R800371	R800114	R800350	R800372	R800373	R323111	R313412
<i>R307388</i>	<i>R31014</i>					R308900	R308901	<i>R308902</i>	<i>R308898</i>

Installation Cables Fiber-optic

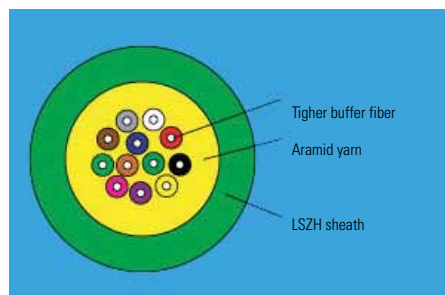

Mini Breakout Cables Indoor

Bandwidth Number	200/500 OM1	500/500 OM2	1500/500 OM3	3500/500 OM4	N/A OS 1/OS 2
2	R314486	R314488	R314490	On request	R314492
4	R304081	R304073	R308315	R512704	R304135
6	R304082	R304074	R308316	R512705	R304136
8	R304083	R304075	R308313	R512706	R304137
12	R304084	R304076	R308318	R512707	R304138
24	R304086	R304078	R308317	R512708	R304140

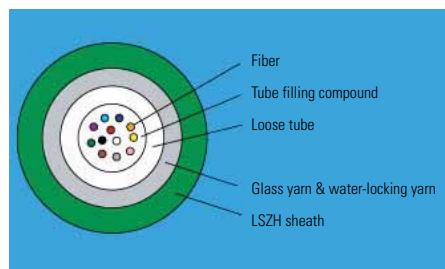

Central Loose Tube Cables Indoor / Outdoor

Bandwidth Number	200/500 OM1	500/500 OM2	1500/500 OM3	3500/500 OM4	N/A OS 1/OS 2
4	R304093	R304088	R308217	R512391	R304143
6	R304094	<i>R304089</i>	<i>R308310</i>	R512392	R304145
8	R304095	R304090	R308218	R512393	R304146
12	R304096	<i>R304091</i>	<i>R308214</i>	R512394	R304147
24	R304097	R304092	<i>R308215</i>	R512395	R304148

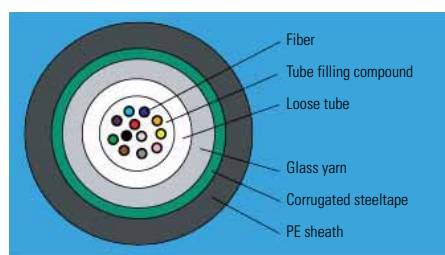

Central Loose Tube Cables / Outdoor (Corrugated Steeltape)

Bandwidth Number	200/500 OM1	500/500 OM2	1500/500 OM3	3500/500 OM4	N/A OS 1/OS 2
6	R312796	R312795	<i>R312794</i>	On request	<i>R312793</i>
8	R314455	R314456	R314457	On request	R314543
12	R304213	R304210	R311390	On request	<i>R304216</i>
24	R304214	R304211	R311391	On request	R304217

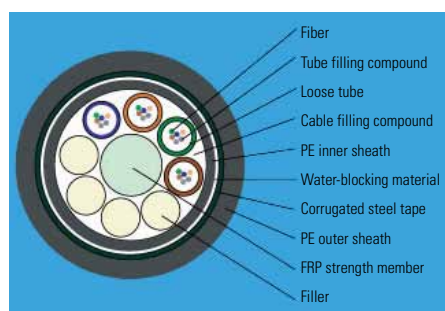

Stranded Loose Tube Cables Outdoor

Bandwidth Number	200/500 OM1	500/500 OM2	1500/500 OM3	3500/500 OM4	N/A OS 1/OS 2
1x12	R314544	R314548	R314552	On request	R314556
2x12	R314545	R314549	R314553	On request	R314557
4x12	R304215	R304212	R311392	On request	R304218
6x12	R314546	R314550	R314554	On request	R314558
8x12	R314547	R314551	R314555	On request	R314559

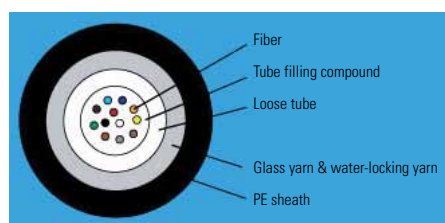

Central Loose Tube Cables / Outdoor

Bandwidth Number	200/500 OM1	500/500 OM2	1500/500 OM3	3500/500 OM4	N/A OS 1/OS 2
4	R314519	R314521	R314523	R512396	R314525
6	R312789	R312791	R312792	R512397	R312797
8	R314520	R314522	R314524	R512398	R314526
12	R304153	R304150	R311387	R512399	R304156
24	R304154	R304151	R311388	R512400	R304157

ALL Packing Unit: 2000m/drum

i Bandwidth (850µm/1300µm)



Right on track

The Raceway System is a cable guiding system specially designed for an individual and safe guiding of optical cables outside the protected area. Guiding optical cables separately from copper lines achieves the highest levels of security and probability of failure-free operation for all networks. The uniquely solid and compact design plus the snap-on mounting system guarantee swift and cost-efficient installation, no special tools are needed. The Raceway System is supplied in six different sizes, providing custom-tailored installation for all optical cable guiding requirements and applications.



get more @ R&M

- Quick installation without special tools
- Snap-on mounting solution
- Secure guiding of optical cables
- Minimum radius 30 mm (R30)
- Market: switchboards, data centers, all fiber-optic cabling installations



Features

- Simple retrofit of covers
- Snap-on joints link the individual components together
- Flame-retardant material: plastic PC/ABS
- Standard color yellow

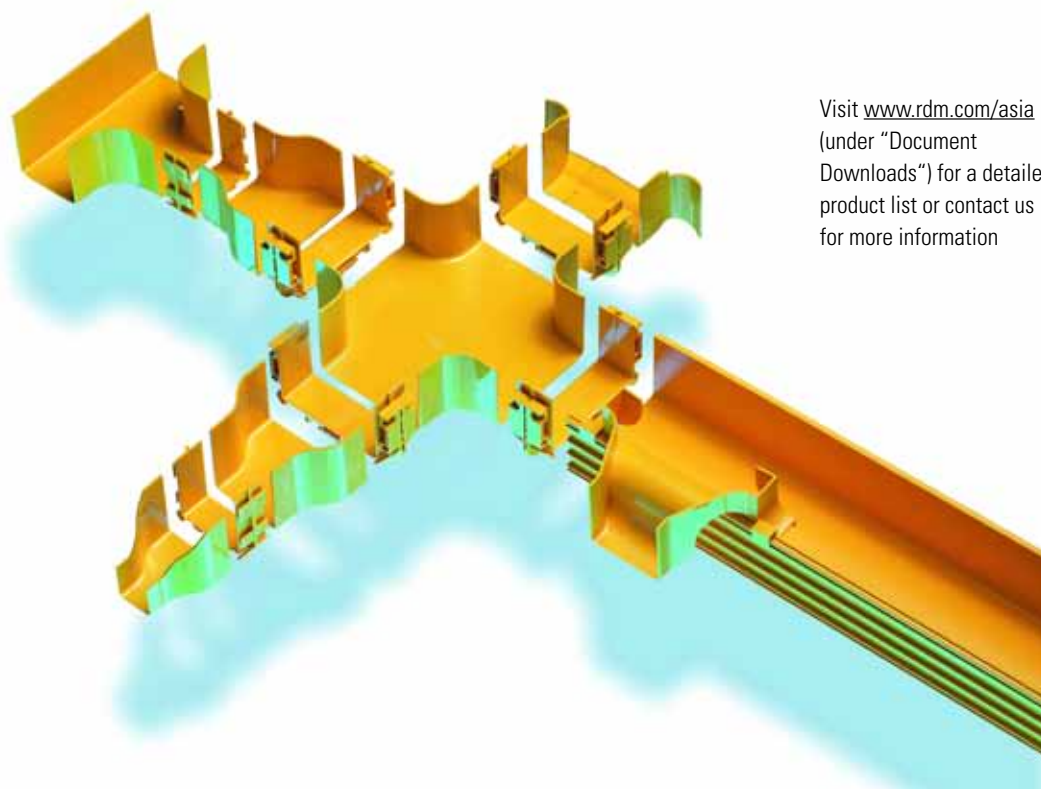

Visit www.rdm.com/asia
(under "Document
Downloads") for a detailed
product list or contact us
for more information

Patch Panels
19" SpliceBox
1U (splice)

010.2292

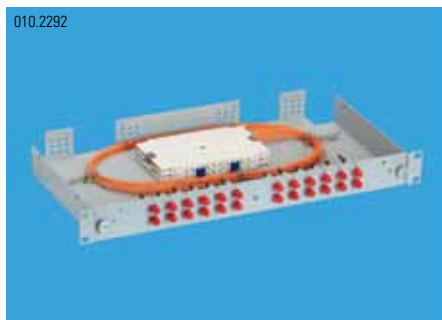

Features

- Up to 24 connectors on one height unit (1U)
- Little mounting depth of 230 mm
- Cable entry from the rear or from the side
- Loose tube and pigtail reserve within splice box
- Labeled front panel

i Loose tubes of a diameter above 3.5 mm can cause mounting problems.
 Pigtails 100% tested and supplied with test report.

Ordering Information

Description

PU

Part Number

090.3126



19" 1U SpliceBox 12xSC-Duplex

Supplied:

- 19" 1U splice box, with 2 splice trays radius 30 mm, fastening material and installation instructions
- Front panel equipped with adapters and pigtails

G.652.D, PC, ceramic, C/2

1

R306892

OM3, PC, PhBr, M/4

1

R308064

OM2, PC, PhBr, M/4

1

R306894

OM1, PC, PhBr, M/4

1

R306893

i Without cover for 19" 1U SpliceBox / BreakoutBox (R306775)

010.2291

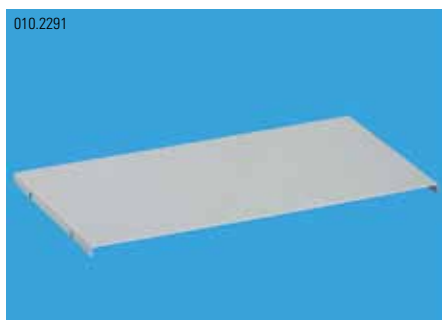

19" 1U SpliceBox / BreakoutBox, cover

- Protection against external mechanical factors
- Opened and closed with a screwdriver
- Color: medium gray (NCS 2502-B)

Supplied:

- Cover (sheet steel)
- 4 screws M4x8 mm

1

R306775





Features

- Up to 24 connectors on one height unit (1U)
- Up to 96 connectors (LC pigtails) on two height unit (2U)
- Simple patch panel mounting and dismounting for splicing
- Little mounting depth of 230 mm
- Universally compatible (e.g. ETSI standard compliant)
- Cable entry from the rear or from the side

i Loose tubes of a diameter above 3.5 mm can cause mounting problems. Connector pigtails 100% tested and supplied with test report.

Splice Holders & Protectors are not included

Ordering Information

	Description	PU	Part Number
090.3145	 <p>19" 1U UniRack 12xSC Duplex, unloaded 19" 1U UniRack 12xSC-Duplex Supplied:</p> <ul style="list-style-type: none"> – 19" 1U slide-in unit, splice tray plate with 2 splice trays radius 40 mm, fastening material, labeling strips and installation manual – Front panel equipped with 12 adapters and 24 pigtails 	1	R300263
	G.652.D, PC, ceramic, C/2	1	R303009
	OM3, PC, PhBr, M/4	1	R308066
	OM2, PC, PhBr, M/4	1	R308495
	OM1, PC, PhBr, M/4	1	R308493
010.2799	 <p>19" 1U UniRack 12xLC Duplex, unloaded 19" 1U UniRack 12xLC Duplex Supplied:</p> <ul style="list-style-type: none"> – 19" 1U slide-in unit, splice tray plate with 2 splice trays radius 40 mm, fastening material, labeling strips and installation manual – Front panel equipped with 12 adapters and 24 connector pigtails 	1	R30398
	OS1, PC, ceramic, C/2	1	R308509
	OM3, PC, PhBr, M/4	1	R308517
	OM2, PC, PhBr, M/4	1	R308515
	OM1, PC, PhBr, M/4	1	R308513
090.5071	 <p>19" 1U UniRack 24xLC Duplex, unloaded 19" 1U UniRack 24xLC-Duplex Supplied:</p> <ul style="list-style-type: none"> – 19" 1U slide-in unit, splice tray plate with 2 splice trays radius 40 mm, fastening material, labeling strips and installation manual – Front panel equipped with 24 adapters and 48 pigtails 	1	R505559
	G.652.D, PC, ceramic, C/2	1	R308510
	OM3, PC, PhBr, M/4	1	R308518
	OM2, PC, PhBr, M/4	1	R308516
	OM1, PC, PhBr, M/4	1	R308514

Patch Panels
19" BreakoutBox
1U (breakout)



Features

- Up to 24 adapters on one height unit (1U)
- Little mounting depth of 230 mm
- Cable entry from the rear or from the side
- Fastening options for cabling systems
- No front-side drawer (fixed rack)

i Adapters 100% tested and supplied with test report.

Ordering Information

Description

PU

Part Number

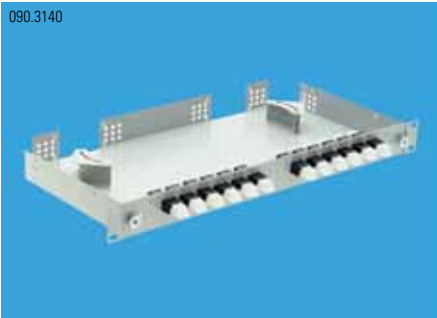

19" 1U BreakoutBox 12xE-2000™-Compact

Supplied:

- 19" 1U breakout box, fastening material and installation instructions
- Front panel equipped with adapters

OM3, PC, PhBr

1

R308886

i Without cover for 19" 1U SpliceBox / BreakoutBox (R306775)



19" 1U BreakoutBox, unloaded

- SC Duplex
- LC Duplex

1

R306884

1

R306885

19" 1U BreakoutBox 12xSC-Duplex

Supplied:

- 19" 1U breakout box, fastening material and installation instructions
- Front panel equipped with adapters

OM1/OM2/OM3, PC, PhBr

1

R306876

i Without cover for 19" 1U SpliceBox / BreakoutBox (R306775)



19" 1U BreakoutBox 12xLC-Duplex

Supplied:

- 19" 1U breakout box, fastening material and installation instructions
- Front panel equipped with adapters

OM1/OM2/OM3, PC, PhBr

1

R314347



Cable Guide

- For the horizontal patch cords routing. Fitted directly to the rack. Applicable when the 19" side mounting brackets are not in back-set position. Patching rings are an equivalent option.
- Color: powder-coated, medium gray, NCS 2502-B
- Material: 1.5 mm sheet steel

Supplied:

- Cable guide
- Velcro fastener 600 mm

75 mm

1

R30315

090.3187



Features

- Easy handling (plug and play)
- Integrated bending radius limiter and hold-down cross
- High packing density, up to 288 fibers per 3U patch panel
- Pre-numbered front plates, extra labeling field

Ordering Information

Description

PU

Part Number

090.3187



MPO Modul 7HP, metal, MTPm - 6xLC-Duplex

- Polishing connector MTP male: PC
- Polishing connector LC: PC
- Supplied:
 - Slide-in unit, radius limiter radius 35mm, labeling strips and installation instructions
- Metal front panel equipped with 6xLC-Duplex adapters and fan-outs inserted, rear side 1 MTP male connector mounted

OM3, PC/PC, ceramic

1

R512763

090.3187



MPO Modul 7HP, metal, 2xMTPm - 12xLC-Duplex

- Polishing connector MTP male: PC
- Polishing connector LC: PC
- Supplied:
 - Slide-in unit, radius limiter radius 35mm, labeling strips and installation instructions
- Metal front panel equipped with 12xLC-Duplex adapters and fan-outs inserted, rear side 2 MTP male connectors mounted

OM3, PC/PC, ceramic

1

R512383

090.3090



MPO Modul 7HP, metal, 2xMTPm - 6xLC-Quad

- Polishing connector MTP male: PC
- Polishing connector LC: PC
- Supplied:
 - Slide-in unit, radius limiter radius 35mm, labeling strips and installation instructions
- Metal front panel equipped with 6xLC-Quad adapters and fan-outs inserted, rear side 2 MTP male connectors mounted

OM3, PC/PC, ceramic

1

R512390

**19" MPO / MTP® Panel
MPO Panel**



Features

- Easy handling (plug and play)
- Integrated bending radius limiter
- High packing density, up to 96 connectors per 1U patch panel
- Little mounting depth of 230 mm
- Universally compatible (e.g. ETSI standard compliant)

Ordering Information

Description

PU

Part Number



19" 1U MPO Panel, 8xMTPm - 24xLC-Quad

- Polishing connector MTP male: PC
- Polishing connector LC: PC

OM3, PC/PC, gray
OM3, PC/PC, black

1
1

R510856
R510857

CREATIVITY

GET MORE. Innovative solutions to meet your customers' requirements. Thanks to extensive investments in Research and Development.

R&M
Convincing cabling solutions



Trunk Cable Features

- High density and backbone cabling
- Plug and play
- Multiple fiber connectivity system
- MTP® 12-fiber female connectors on both sides
- LSZH und plenum (OFNP) jacket
- Polarity method A (TIA-568-C)
- Geometrical specifications of MPO/MTP® connectors acc. to IEC 61754-7
- Factory terminated and tested
- Test report supplied with each cable assembly



Harness Cable Features

- High density and backbone cabling
- Multiple fiber connectivity system
- MTP® 12-fiber male connector on side A
- 12 x LC simplex connectors on Side B
- LSZH und plenum (OFNP) jacket
- Geometrical specifications of MPO/MTP® connector acc. to IEC 61754-7, LC connectors acc. to IEC 61754-20– Delivered with pulling eye on side B
- Factory terminated and test report supplied with each cable assembly

Ordering Information

Description

PU

Part Number



Trunk Cable, 12 fibers, 12MTPf PC- 12MTPf PC

- Both sides fitted with 12MTP PC female connector
- Connector color: black
- Frame color: turquoise
- Fiber: MM G50/125
- Cable: turquoise

OM3, LSZH, 10 m	1	R511914
OM3, LSZH, 20 m	1	R511915
OM4, LSZH, 10 m	1	R511917
OM4, LSZH, 20 m	1	R511918



Harness Cable, 12 fibers, 12MTPm PC - LC PC 12x

- Fitted with 12MTP male PC and 12 LC PC connector
 - Connector color 12MTP: black
 - Frame color 12MTP: turquoise
 - Connector color LC: beige
 - Fiber: MM G50/125
 - Cable: turquoise
- Supplied:
- Cable terminated with connectors
 - Including pulling eye

OM3, LSZH, 10 m	1	R511929
OM3, LSZH, 20 m	1	R511930
OM4, LSZH, 10 m	1	R511932
OM4, LSZH, 20 m	1	R511933

Splice Trays
Splice Tray Radius 40 mm

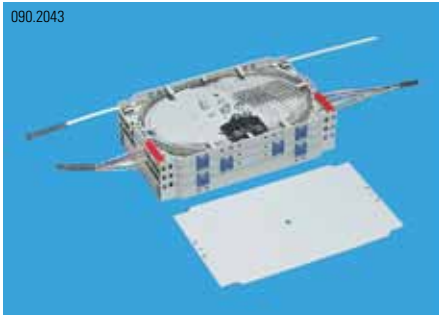

Features

- Capacity of 24 splice connections
- Stackable trays, featuring hinges and fixing strap
- Min. 1.5 m spare length per fiber
- Hinge-fastened cover
- Storing option for unspliced fibers
- Detachable fiber hold-down plates for large splice holders
- Bending radius 40 mm

Ordering Information

Description

PU

Part Number

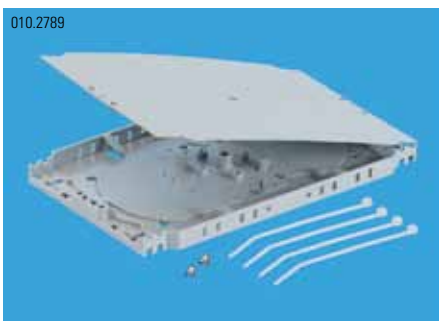

Splice Tray Basic Set R40

- To splice and store the first 24 FO terminations
- Color: medium gray (NCS 2502-B)
- Material: plastic (PC+ABS)
- Dimensions: 116x12.5x188 mm (WxHxD)
- Supplied:
 - 1 splice tray R40
 - 1 cover for splice tray R40
 - 4 cable ties
 - 2 screws for splice holder
 - Installation instructions

1

R308445





Splice Tray Additional Set R40

- For the modular stacking of additional 24 FO terminations per set
- Color: medium gray (NCS 2502-B)
- Material: plastic (PC+ABS)
- Dimensions: 116x10.5x188 mm (WxHxD)
- Supplied:
 - 1 splice tray R40
 - 4 film hinges, small, for stacking
 - 4 cable ties
 - 2 screws for splice holder
 - Installation instructions

1

R308444

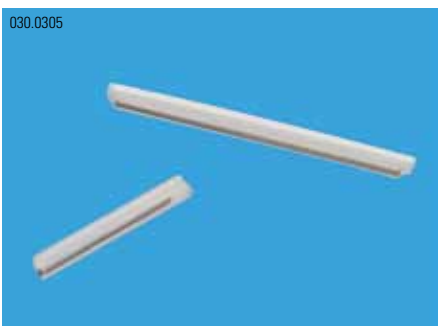

Ordering Information	Description	PU	Part Number
 <p>000.0000</p>	<p>Splice Holder R30/R40, 6x shrink splice protection</p> <ul style="list-style-type: none"> – Suitable for splice trays radius 30/35/40 mm – Max. capacity: 6 heat shrink splice protection – Color: black – Material: plastic (POM) – Dimensions: 27x5x37 mm (WxHxD) <p>Supplied:</p> <ul style="list-style-type: none"> – Splice holder – M3 fastening screw plus plastic screw 	10	R30039-06
 <p>010.2791</p>	<p>Splice Holder R40, splice protection ANT / shrink splice protection</p> <ul style="list-style-type: none"> – Capacity of max. 12x sandwich splice protection or max. 12x heat shrink type 35 mm – Suitable for splice trays 35 mm – Color: medium gray (NCS 2502-B) – Material: plastic (PC+ABS) – Dimension: 30x4.5x72 mm (WxHxD) <p>Supplied:</p> <ul style="list-style-type: none"> – Splice holder – M3 fastening screw plus plastic screw 	1	R308448
 <p>030.0305</p>	<p>Heat Shrink Splice Protection</p> <ul style="list-style-type: none"> – Shrink tube with metal insert 	12 50 12	R30087 R319212 R30087-35
 <p>030.0104.1</p>	<p>Strain Relief 12 Fibers Ø 0.9-1.1 mm, red</p> <ul style="list-style-type: none"> – For the strain relief of 12 FO individual optical fibers of Ø 0.9 to 1.1 mm – To snap onto splice trays radius 30/40 mm – Color: red – Material: plastic (PC) – Dimensions: 30x6x7.5 mm (WxHxD) 	10	R30203

Security System



Security level 1 (visual color coding)

The visual color coding supports correct connecting of the respective copper and fiberoptic cables. The color coding clips are easily clipped to connection cables and ports (outlets, patch panels). When applications are reassigned within the network, the color coding elements are simply moved or replaced, no tools needed.

Ordering Information

Description

PU

Part Number



Color Coding Interbus IP67 Mounting Frame

– Color coding clips suitable for RJ45 IP67 connectors, SC-RJ IP67 connectors and adapter frames

Supplied:

- 50 coding clips, white
- 50 coding clips, blue
- 50 coding clips, orange
- 50 coding clips, yellow

1

R310262



Fiber Guard SC-RJ Adapter

– SC-RJ connection protection for outlets and patch panels

– Fitting R&M Smartholes

Supplied:

- Fiber Guard
- 1 key per packing unit

12

R310218

R&M's modular Security System

Neutral studies prove that 70% of all network failures and crashes result from faulty cabling infrastructure or erroneous manipulation of connecting cables. When evaluating the passive network system it is important to carefully check if security aspects are integrally supported and smoothly implemented.

Security level 1: The optical color coding supports correct connecting of the respective cables. The color coding elements are easily clipped to connection cables and ports (outlets, patch panels).

Security level 2: The mechanical-visual coding elements provide additional security on a mechanical level. They simply and effectively prevent cables from being plugged into wrong ports by mistake.

Security level 3: These products introduce future-proof security to network connections. Only trained and authorized staff can release connections. Authorizing connection points access is also an option.

030.0667



Features:

- To snap onto back mount frames or mounting profiles
- Packing density of up to 4200 pairs/m²
- Wiring in IDC technology without expensive tools
- Gold-plated contacts
- Protection components ensure permanent person and equipment protection
- Protection components are plugged in at the front
- Contacts for disconnection and testing at the front
- Module bodies made of one piece

Ordering Information

Description

PU

Part Number

030.0666

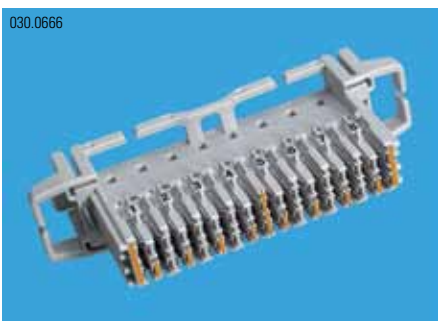

8-Pair Module

- Grid size: 20 mm
- Supplied:
 - VS Compact module, printed
 - Installation instructions
 - Mini tool (wiring tool)

Connection Module 8 pairs (20 mm)	10	R300035
Disconnection Module 8 pairs (20 mm)	10	R300036
Normally Open Module 8 pairs (20 mm)	10	R300037

030.0667



10-Pair Module

- Grid size: 20 mm
- Supplied:
 - VS Compact module, printed
 - Installation instructions
 - Mini tool (wiring tool)

Connection Module 10 pairs (20 mm)	10	R300039
Disconnection Module 10 pairs (20 mm)	10	R300040
Normally Open Module 10 pairs (20 mm)	10	R300041

030.0668

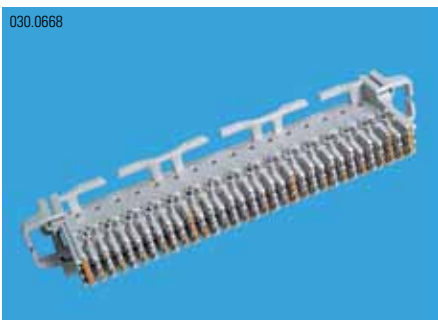

16-Pair Module

- Grid size: 25 mm
- Supplied:
 - VS Compact module, printed
 - Installation instructions
 - Mini tool (wiring tool)

Connection Module 16 pairs (25 mm)	10	R300045
Disconnection Module 16 pairs (25 mm)	10	R300046
Normally Open Module 16 pairs (25 mm)	10	R300047

030.0669



20-Pair Module

- Grid size: 25 mm
- Supplied:
 - VS Compact module, printed
 - Installation instructions
 - Mini tool (wiring tool)

Connection Module 20 pairs (25 mm)	10	R300049
Disconnection Module 20 pairs (25 mm)	10	R300050
Normally Open Module 20 pairs (25 mm)	10	R300051

**Connection System
Connection Modules**

010.2188

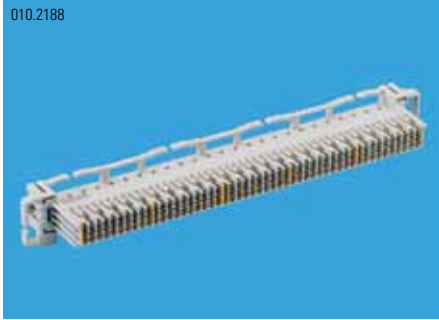

25-Pair Module

- Grid size: 25 mm
- Supplied:
 - VS Compact module, printed
 - Installation instructions
 - Mini tool (wiring tool)

Connection Module 25 pairs (25 mm)	10	R300674
Disconnection Module 25 pairs (25 mm)	10	R300675
Normally Open Module 25 pairs (25 mm)	10	R300757

010.3058

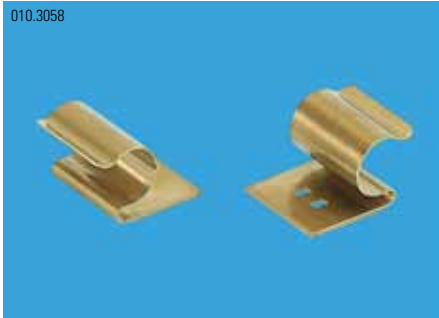

Round Profile Adapter Kit

- Used for mounting VS Compact modules of grid size 20/25 mm onto round profiles of \varnothing 12mm
- Supplied:
 - 2 round profile adapters

	10	R300669
--	----	---------

DENSITY

GET MORE. The grid size of 10 mm doubles the connection capacity. More space with full Cat. 5e performance.

R&M
Convincing cabling solutions

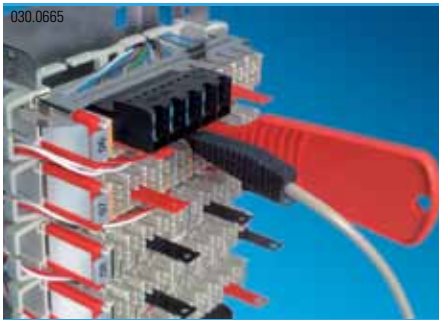

Ordering Information

Description

PU

Part Number



Disconnection Plug

- To disconnect the lines between cable side and jumper side in disconnection modules
- Material: POM

1 pair, black

100

R300067



Marking Plug

- To identify individual lines, suitable for all VS Compact modules
- Ideal for protection from inadvertent disconnection in disconnection modules
- Material: plastic (POM)

1 pair, red

100

R300066



Designation Clip

- For the labeling of all VS Compact modules
- Can be snapped on at both sides of a module

Supplied:

- 20 designation clips
- Labeling sheet

red

20

R300292

black

20

R300293

yellow

20

R300294

blue

20

R300295

Connection System
Protection Components
Primary Protection

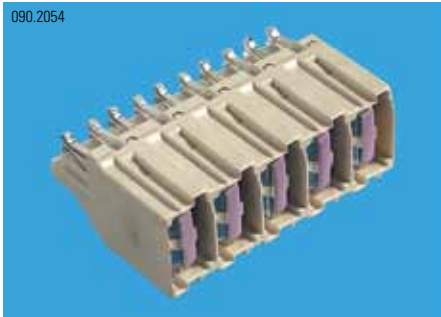

Ordering Information

Description

PU

Part Number

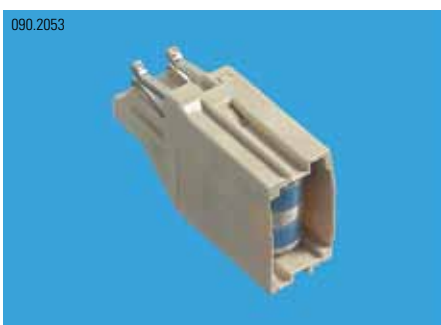

Protection Magazine 1 pair, equipped

- Suitable for all VS Compact modules
- Supplied:
 - Protection magazine, empty
 - 3-electrode arrester 6x8 mm, 2x5 kA, 230 V
 - Installation instructions

with arrester without failsafe (FS)

10

R304955

with arrester with FS plus FS display

10

R304957

i For overvoltage protection a grounding rail is required



Protection Magazine 5 pairs, equipped

- Suitable for all VS Compact modules from 5 pairs up
- Supplied:
 - Protection magazine, empty
 - Five 3-electrode arresters 6x8 mm, 2x5 kA, 230 V
 - Installation instructions

with arrester without failsafe (FS)

20

R304956

with arrester with FS plus FS display

20

R304958

i For overvoltage protection a grounding rail is required

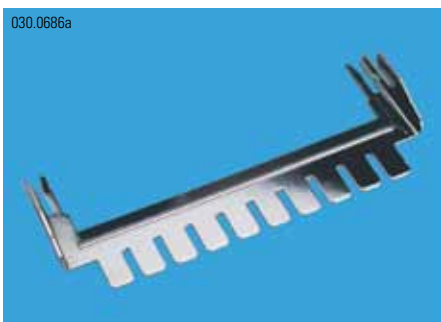

Grounding Rail

- Connects protection magazine and ground of the VS Compact back mount frame
- The grounding plates are plugged in at the front of the modules

8 pairs

10

R300761

10 pairs

100

R300092

16 pairs

10

R300094

20 pairs

10

R300095

25 pairs

10

R305209

010.1749.1



Features

- Plugged in at the front
- Suitable for VS Compact disconnection and normally open modules
- Featuring measuring and test contact

Ordering Information

Description

PU

Part Number

010.1748

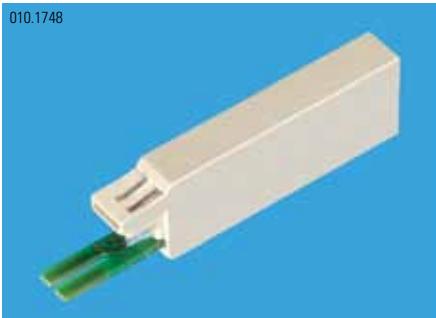

Protection Plug 230 V/150 mA

- 1-pair protection plug featuring 3-electrode arrester (2 x 5 kA, 230 V FS) and 150 mA PTC
- Includes measuring and test contact interface
- Can be plugged into all VS Compact disconnection and normally open modules in combination with the grounding rail

Subscriber side

10

R302101

Inverse exchange side

10

R302102

FLXIBILITY

GET MORE. Custom-made, flexible solutions. Thanks to a customer-oriented corporate culture.

R&M
Convincing cabling solutions

**Indoor Distributors
Distribution Frames and Accessories**

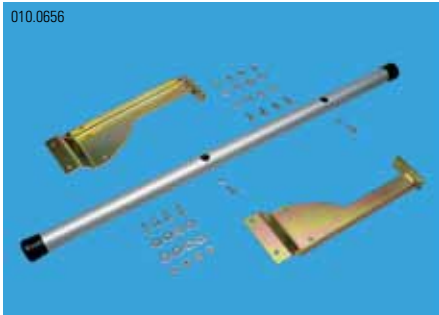

Ordering Information

Description

PU

Part Number

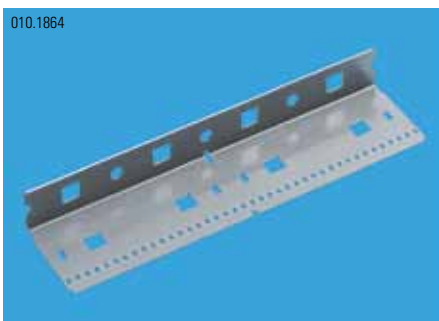

Mounting Profile, 20/25 mm

- Mounting profile (depth x length)
- Grid size: 20/25 mm
- Material: steel (1.4301)

50 x 400 mm

1

R300014

100 x 1000 mm

1

R301863

i To mount one VS Compact connection module two mounting profiles are required.



Transfer Ring, large

- For snap-on side mounting to mounting profiles and back mount frames
- Min. profile depth required 100 mm

1

R301050



Transfer Strap

- To be screwed on at the side of a mounting profile or back mount frame
- Min. profile depth required for mounting is 50 mm

Supplied:

- Transfer strap, made of steel (1.4301), chromium-plated
- Mounting plate
- Edge protection profile
- 2 fastening screws M6 x 12
- 2 washers M6
- 2 counternuts M6

1

R300025

030.0775

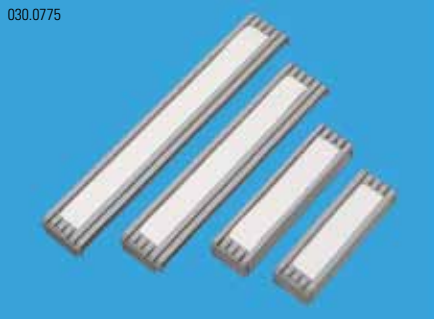

Label Holder

- For the labeling of blocks and verticals
- Directly attachable to mounting profiles
- Dimensions: width x grid size (mm)

Supplied:

- Label holder frame and cover
- Labeling strips

8 pairs, 64x20

10 R300664

10 pairs, 78x20

10 R300665

16 pairs, 120x25

10 R300666

20 pairs, 148x25

10 R300667

25 pairs, 184x25

10 R305208

030.0763

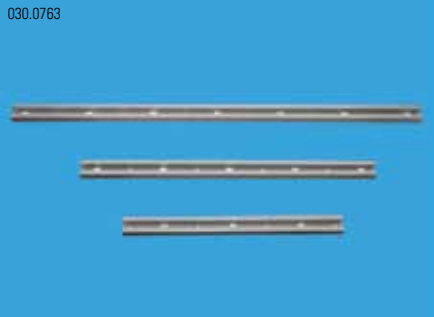

Wall Rail Kit

- Required for attaching VS Compact mounting profiles to walls

Supplied:

- 2 wall rails (length)
- 6 insulating sleeves
- 6 insulating disks
- 2 end pieces

500 mm

1 R300768

1000 mm

1 R300769

1500 mm

1 R300770

030.0764

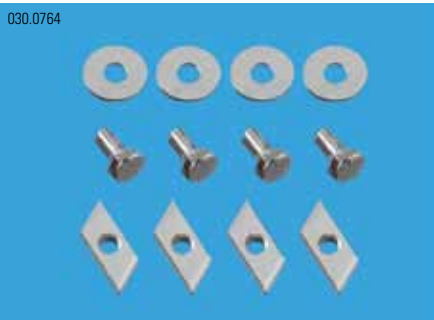

Mounting Kit 90°

- For the direct attachment of mounting profiles to wall rails

Supplied:

- 4 fastening screws M6 x 12
- 4 washers
- 4 slide nuts

1 R301058

010.2234

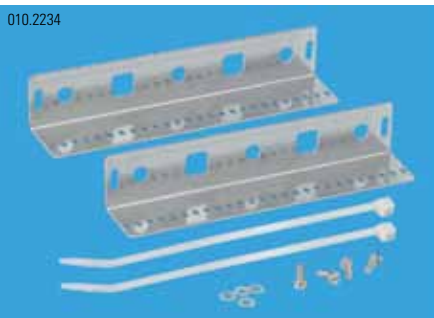

19" Mounting Profile Kit, 20/25 mm

- Mounting profiles fitting empty 19" 3U sub-racks

Maximum capacity:

- 6 modules of grid size 20 mm
- 5 modules of grid size 25 mm

Supplied:

- 2 mounting profiles for 19" sub-racks
- Mounting kit (4 screws, washers)
- 2 cable ties, large

1 R300663

010.2240



19" Sub-Rack, 3U

- Used for fastening the mounting profiles for VS Compact modules
- The sub-rack accepts 2 to 4 mounting profile kits, depending on module size

Maximum capacity:

- 4 19" splitter back mount frames
- 4 mounting profile kits, 8/10 pairs
- 3 mounting profile kits, 16 pairs
- 2 mounting profile kits, 20/25 pairs

Supplied:

- 19" sub-rack, empty
- Grounding flex plus M5 cable lug
- M5 x 10 grounding flex fastening screw
- 19" mounting kit (4 screws, plastic washers, cage nuts)
- Installation instructions

1 R300662

Patch and Connection Cords



Ordering Information

Description

PU

Part Number



Connection Cord 1 pair

- Fitted with a VS Compact 1-pair test plug on both sides
- Contact interface on patching and cable side

2.5 m

1

R302604



010.3057

Patch Cord 1 pair

- Fitted with a VS Compact plug on one end and a RJ45 connector on the other
- For direct patching of VS Compact to RJ45

VS-RJ45 (3/6), 2.0 m

1

R307232

VS-RJ45 (4/5), 2.0 m

1

R307231

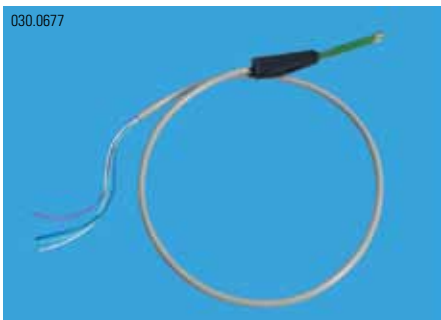

030.0677

Test Cord "Universal"

- Test cord for customer assembly
- For use as test adapter to connect all types of test equipment
- Contact interface on cable and jumper side
- Open cable end

2.5 m, without snap-in stop

1

R300073



Ordering Information

Description

PU

Part Number



030.0673a

Wiring Tool

- For wiring all VS Compact modules
- The wires are contacted and cut to length in one single and efficient step
- Material: plastic (PA66-GF25)

Supplied:

- One Mini Tool is supplied for free with 10 VS Compact modules.

"Mini Tool"

10

R300068



030.0673c

Wiring Tool

- For wiring all VS Compact modules
- The wires are contacted and cut to length in one single and efficient step
- Material: plastic (PA66-GF25), chrome-nickel-steel

Supplied:

- Wiring tool recommended for wire diameter 0.8 mm
- The tip is made of metal
- Features a hook to remove jumper wires from the modules

"Comfort Tool"

10

R300069

Index

Part No	Product	Page No
R101872	Power Module 45 x 45, British power socket for DESKbox	46
R101915	Power Module 45 x 45, Germany power socket for DESKbox	46
R101916	Power Module 45 x 45, China power socket for DESKbox	46
R101917	Power Module 45 x 45, Euro US power socket for DESKbox	46
R300014	Mounting Profile, 20/25 mm, 50 x 400 mm	75
R300025	Transfer Strap	75
R300035	8-Pair Module, Connection Module 8 pairs (20 mm)	70
R300036	8-Pair Module, Disconnection Module 8 pairs (20 mm)	70
R300037	8-Pair Module, Normally Open Module 8 pairs (20 mm)	70
R300039	10-Pair Module, Connection Module 10 pairs (20 mm)	70
R300040	10-Pair Module, Disconnection Module 10 pairs (20 mm)	70
R300041	10-Pair Module, Normally Open Module 10 pairs (20 mm)	70
R300045	16-Pair Module, Connection Module 16 pairs (25 mm)	70
R300046	16-Pair Module, Disconnection Module 16 pairs (25 mm)	70
R300047	16-Pair Module, Normally Open Module 16 pairs (25 mm)	70
R300049	20-Pair Module, Connection Module 20 pairs (25 mm)	70
R300050	20-Pair Module, Disconnection Module 20 pairs (25 mm)	70
R300051	20-Pair Module, Normally Open Module 20 pairs (25 mm)	70
R300066	Marking Plug, 1 pair, red	72
R300067	Disconnection Plug, 1 pair, black	72
R300068	Wiring Tool, "Mini Tool"	78
R300069	Wiring Tool, "Comfort Tool"	78
R300073	Test Cord "Universal", 2.5 m, without snap-in stop	77
R300092	Grounding Rail, 10 pairs	73
R300094	Grounding Rail, 16 pairs	73
R300095	Grounding Rail, 20 pairs	73
R300116	Patch Cord SC-RJ PC - SC-RJ PC, OM2, M/4, 1m	58
R300117	Patch Cord SC-RJ PC - SC-RJ PC, OM2, M/4, 2m	58
R300118	Patch Cord SC-RJ PC - SC-RJ PC, OM2, M/4, 3m	58
R300120	Patch Cord SC-RJ PC - SC-RJ PC, OM2, M/4, 5m	58
R300121	Patch Cord SC-RJ PC - SC-Duplex PC, OM2, M/4, 1m	57
R300121	Patch Cord SC-Duplex PC - SC-RJ PC, OM2, M/4, 1m	58
R300122	Patch Cord SC-RJ PC - SC-Duplex PC, OM2, M/4, 2m	57
R300122	Patch Cord SC-Duplex PC - SC-RJ PC, OM2, M/4, 2m	58
R300123	Patch Cord SC-RJ PC - SC-Duplex PC, OM2, M/4, 3m	57
R300123	Patch Cord SC-Duplex PC - SC-RJ PC, OM2, M/4, 3m	58
R300125	Patch Cord SC-RJ PC - SC-Duplex PC, OM2, M/4, 5m	57
R300125	Patch Cord SC-Duplex PC - SC-RJ PC, OM2, M/4, 5m	58
R300126	Patch Cord SC-RJ PC - SC-Duplex PC, OM1, M/4, 1m	57
R300126	Patch Cord SC-Duplex PC - SC-RJ PC, OM1, M/4, 1m	58
R300127	Patch Cord SC-RJ PC - SC-Duplex PC, OM1, M/4, 2m	57
R300127	Patch Cord SC-Duplex PC - SC-RJ PC, OM1, M/4, 2m	58
R300128	Patch Cord SC-RJ PC - SC-Duplex PC, OM1, M/4, 3m	57
R300128	Patch Cord SC-Duplex PC - SC-RJ PC, OM1, M/4, 3m	58
R300130	Patch Cord SC-RJ PC - SC-Duplex PC, OM1, M/4, 5m	57
R300130	Patch Cord SC-Duplex PC - SC-RJ PC, OM1, M/4, 5m	58
R300131	Patch Cord SC-RJ PC - ST PC, OM2, M/4, 1m	57
R300131	Patch Cord ST PC - SC-RJ PC, OM2, M/4, 1m	58
R300132	Patch Cord SC-RJ PC - ST PC, OM2, M/4, 2m	57
R300132	Patch Cord ST PC - SC-RJ PC, OM2, M/4, 2m	58
R300133	Patch Cord SC-RJ PC - ST PC, OM2, M/4, 3m	57
R300133	Patch Cord ST PC - SC-RJ PC, OM2, M/4, 3m	58
R300135	Patch Cord SC-RJ PC - ST PC, OM2, M/4, 5m	57
R300135	Patch Cord ST PC - SC-RJ PC, OM2, M/4, 5m	58
R300263	19" 1U UniRack 12xSC Duplex, unloaded	62
R300292	Designation Clip, red	72
R300293	Designation Clip, black	72
R300294	Designation Clip, yellow	72
R300295	Designation Clip, blue	72
R300317	Installation Cable Cat.5e, F/UTP, 4P, 200 MHz, PVC, 305m	11
R30039-06	Splice Holder R30/R40, 6x shrink splice protection	68
R300662	19" Sub-Rack, 3U	76
R300663	19" Mounting Profile Kit, 20/25 mm	76
R300664	Label Holder, 8 pairs, 64x20	76

Part No	Product	Page No
R300665	Label Holder, 10 pairs, 78x20	76
R300666	Label Holder, 16 pairs, 120x25	76
R300667	Label Holder, 20 pairs, 148x25	76
R300669	Round Profile Adapter Kit	71
R300674	25-Pair Module, Connection Module 25 pairs (25 mm)	71
R300675	25-Pair Module, Disconnection Module 25 pairs (25 mm)	71
R300757	25-Pair Module, Normally Open Module 25 pairs (25 mm)	71
R300761	Grounding Rail, 8 pairs	73
R300768	Wall Rail Kit, 500 mm	76
R300769	Wall Rail Kit, 1000 mm	76
R300770	Wall Rail Kit, 1500 mm	76
R30087	Heat Shrink Splice Protection, 3x65 mm	68
R30087-35	Heat Shrink Splice Protection, 3x35 mm	68
R301050	Transfer Ring, large	75
R301058	Mounting Kit 90°	76
R301461	Pigtail SC, OM2, M/4, 2.5m	57
R301462	Pigtail SC, OM1, M/4, 2.5m	57
R301863	Mounting Profile, 20/25 mm, 100 x 1000 mm	75
R30203	Strain Relief 12 Fibers Ø 0.9-1.1 mm, red	68
R302089	Installation Cable Cat.5e, SF/UTP, 4P, 200 MHz, LSZH, 500m	11
R302101	Protection Plug 230 V/150 mA, Subscriber side	74
R302102	Protection Plug 230 V/150 mA, Inverse exchange side	74
R302151	Snap-in Coding Clip, anthracite	48
R302152	Snap-in Coding Clip, blue	48
R302153	Snap-in Coding Clip, brown	48
R302154	Snap-in Coding Clip, green	48
R302155	Snap-in Coding Clip, red	48
R302156	Snap-in Coding Clip, violet	48
R302157	Snap-in Coding Clip, white	48
R302158	Snap-in Coding Clip, yellow	48
R302309	Patch Cord Cat.6, U/UTP, 4P, LSZH, RJ45/u-RJ45/u, 0.5m, gray	30
R302310	Patch Cord Cat.6, U/UTP, 4P, LSZH, RJ45/u-RJ45/u, 1.0m, gray	30
R302311	Patch Cord Cat.6, U/UTP, 4P, LSZH, RJ45/u-RJ45/u, 1.5m, gray	30
R302312	Patch Cord Cat.6, U/UTP, 4P, LSZH, RJ45/u-RJ45/u, 2.0m, gray	30
R302313	Patch Cord Cat.6, U/UTP, 4P, LSZH, RJ45/u-RJ45/u, 3.0m, gray	30
R302314	Patch Cord Cat.6, U/UTP, 4P, LSZH, RJ45/u-RJ45/u, 5.0m, gray	30
R302315	Patch Cord Cat.6, U/UTP, 4P, LSZH, RJ45/u-RJ45/u, 7.5m, gray	30
R302316	Patch Cord Cat.6, U/UTP, 4P, LSZH, RJ45/u-RJ45/u, 10.0m, gray	30
R302317	Patch Cord Cat.6, U/UTP, 4P, LSZH, RJ45/u-RJ45/u, 12.5m, gray	30
R302318	Patch Cord Cat.6, U/UTP, 4P, LSZH, RJ45/u-RJ45/u, 15.0m, gray	30
R302319	Patch Cord Cat.6, U/UTP, 4P, LSZH, RJ45/u-RJ45/u, 20.0m, gray	30
R302331	Patch Cord Real10 Cat.6, S/FTP, 4P, LSFRZH, RJ45/s-RJ45/s, 0.5m	30
R302332	Patch Cord Real10 Cat.6, S/FTP, 4P, LSFRZH, RJ45/s-RJ45/s, 1.0m	30
R302333	Patch Cord Real10 Cat.6, S/FTP, 4P, LSFRZH, RJ45/s-RJ45/s, 1.5m	30
R302334	Patch Cord Real10 Cat.6, S/FTP, 4P, LSFRZH, RJ45/s-RJ45/s, 2.0m	30
R302335	Patch Cord Real10 Cat.6, S/FTP, 4P, LSFRZH, RJ45/s-RJ45/s, 3.0m	30
R302336	Patch Cord Real10 Cat.6, S/FTP, 4P, LSFRZH, RJ45/s-RJ45/s, 5.0m	30
R302337	Patch Cord Real10 Cat.6, S/FTP, 4P, LSFRZH, RJ45/s-RJ45/s, 7.5m	30
R302338	Patch Cord Real10 Cat.6, S/FTP, 4P, LSFRZH, RJ45/s-RJ45/s, 10.0m	30
R302339	Patch Cord Real10 Cat.6, S/FTP, 4P, LSFRZH, RJ45/s-RJ45/s, 12.5m	30
R302340	Patch Cord Real10 Cat.6, S/FTP, 4P, LSFRZH, RJ45/s-RJ45/s, 15.0m	30
R302342	Color Coding, anthracite	47
R302343	Color Coding, blue	47
R302344	Color Coding, brown	47
R302345	Color Coding, yellow	47
R302347	Color Coding, gray	47
R302348	Color Coding, green	47
R302349	Color Coding, red	47
R302360	19" 3U Global PP 48xRJ45/s, Real10 Cat.6	23
R302361	19" 3U Global PP 48xRJ45/u, Cat.6	23
R302362	19" 3U Global PP 60xRJ45/s, Real10 Cat.6	25
R302363	19" 3U Global PP 60xRJ45/u, Cat.6	24
R302372	Connection Module Real10 Cat.6, 1xRJ45/s	3
R302373	Connection Module Cat.6, 1xRJ45/u	3

Part No	Product	Page No	Part No	Product	Page No
R302418	Patch Cord Real10 Cat.6, S/FTP, 4P, LSRFRZH, RJ45/s-RJ45/s, 20.0m	30	R304140	Mini Breakout Cable I-V(ZN=B)H, OS1/OS2, 24-fibers	59
R302420	Color Coding, violet	47	R304143	Central Loose Tube Cable I/A-DQ(ZN=B)H, OS1/OS2, 4-fibers	59
R302518	Connection Module Cat.5e, 1xRJ45/u, Snap-in	5	R304145	Central Loose Tube Cable I/A-DQ(ZN=B)H, OS1/OS2, 6-fibers	59
R302604	Connection Cord 1 pair, 2.5m	77	R304146	Central Loose Tube Cable I/A-DQ(ZN=B)H, OS1/OS2, 8-fibers	59
R302724	FLEXkanal, 1m, black gray	51	R304147	Central Loose Tube Cable I/A-DQ(ZN=B)H, OS1/OS2, 12-fibers	59
R302780	Connection Module Cat.5e, 1xRJ45/s, Snap-in	5	R304148	Central Loose Tube Cable I/A-DQ(ZN=B)H, OS1/OS2, 24-fibers	59
R303009	19" 1U UniRack 12xSC-Duplex, G.652.D, PC, ceramic, C/2	62	R304150	Central Loose Tube Cable A-DQ(ZN)B2Y, OM2, 12-fibers	59
R30315	Cable Guide, 75mm	63	R304151	Central Loose Tube Cable A-DQ(ZN)B2Y, OM2, 24-fibers	59
R303154	Mounting Plate Flap Jack 86x86, 2x1-Port, pure white	39	R304153	Central Loose Tube Cable A-DQ(ZN)B2Y, OM1, 12-fibers	59
R303155	Module Holder Flap Jack (Type 6C), 1-Port, pure white	39	R304154	Central Loose Tube Cable A-DQ(ZN)B2Y, OM1, 24-fibers	59
R303343	Patch Cord SC-Duplex PC - SC-Duplex PC, OS1, 2m	58	R304156	Central Loose Tube Cable A-DQ(ZN)B2Y, OS1/OS2, 12-fibers	59
R303344	Patch Cord SC-Duplex PC - SC-Duplex PC, OS1, 3m	58	R304157	Central Loose Tube Cable A-DQ(ZN)B2Y, OS1/OS2, 24-fibers	59
R303346	Patch Cord SC-Duplex PC - SC-Duplex PC, OS1, 5m	58	R304210	Central Loose Tube Cable A-D(ZN)W2Y, OM2, 12-fibers	59
R303561	Adapter SC-Duplex, PC, beige, PhBr MM, N	53	R304211	Central Loose Tube Cable A-D(ZN)W2Y, OM2, 24-fibers	59
R303901	Mini Surface Mount Box, 1-Port, cream	35	R304212	Stranded Loose Tube Cables A-DF(ZN)2YW2Y, OM2, 4x12-fibers	59
R303970	Patch Cord SC-Duplex PC - ST PC, OM2, M/4, 1m	57	R304213	Central Loose Tube Cable A-D(ZN)W2Y, OM1, 12-fibers	59
R303970	Patch Cord ST PC - SC-Duplex PC, OM2, M/4, 1m	57	R304214	Central Loose Tube Cable A-D(ZN)W2Y, OM1, 24-fibers	59
R303971	Patch Cord SC-Duplex PC - ST PC, OM2, M/4, 2m	57	R304215	Stranded Loose Tube Cables A-DF(ZN)2YW2Y, OM1, 4x12-fibers	59
R303971	Patch Cord ST PC - SC-Duplex PC, OM2, M/4, 2m	57	R304216	Central Loose Tube Cable A-D(ZN)W2Y, OS1/OS2, 12-fibers	59
R303972	Patch Cord SC-Duplex PC - ST PC, OM2, M/4, 3m	57	R304217	Central Loose Tube Cable A-D(ZN)W2Y, OS1/OS2, 24-fibers	59
R303972	Patch Cord ST PC - SC-Duplex PC, OM2, M/4, 3m	57	R304218	Stranded Loose Tube Cables A-DF(ZN)2YW2Y, OS1/OS2, 4x12-fibers	59
R303974	Patch Cord SC-Duplex PC - ST PC, OM2, M/4, 5m	57	R304275	503 Outlet 118x72, 4x1-Port, pure white	37
R303974	Patch Cord ST PC - SC-Duplex PC, OM2, M/4, 5m	57	R304325	Connection Module Cat.5e, 100xRJ45/s	5
R303975	Patch Cord SC-Duplex PC - ST PC, OM1, M/4, 1m	57	R304326	Connection Module Cat.5e, 100xRJ45/u	5
R303975	Patch Cord ST PC - SC-Duplex PC, OM1, M/4, 1m	57	R304327	Connection Module Real10 Cat.6, 100xRJ45/s	3
R303976	Patch Cord SC-Duplex PC - ST PC, OM1, M/4, 2m	57	R304328	Connection Module Cat.6, 100xRJ45/u	3
R303976	Patch Cord ST PC - SC-Duplex PC, OM1, M/4, 2m	57	R304373	Connection Module Real10 Cat.6, 1xRJ45/s, Snap-in	4
R303977	Patch Cord SC-Duplex PC - ST PC, OM1, M/4, 3m	57	R304374	Connection Module Cat.6, 1xRJ45/u, Snap-in	4
R303977	Patch Cord ST PC - SC-Duplex PC, OM1, M/4, 3m	57	R304777	Mini Surface Box, 2x1-Port with magnet	35
R303979	Patch Cord SC-Duplex PC - ST PC, OM1, M/4, 5m	57	R304807	Safe Clip	49
R303979	Patch Cord ST PC - SC-Duplex PC, OM1, M/4, 5m	57	R304825	Plug Guard, green	49
R30398	19" 1U UniRack 12xLC Duplex, unloaded	62	R304826	Plug Guard, red	49
R303980	Patch Cord SC-Duplex PC - SC-Duplex PC, OM2, M/4, 1m	57	R304827	Plug Guard, white	49
R303981	Patch Cord SC-Duplex PC - SC-Duplex PC, OM2, M/4, 2m	57	R304828	Key Plug Guard / Fiber Guard	49
R303982	Patch Cord SC-Duplex PC - SC-Duplex PC, OM2, M/4, 3m	57	R304955	Protection Magazine 1 pair, equipped, with arrester without failsafe (FS)	73
R303984	Patch Cord SC-Duplex PC - SC-Duplex PC, OM2, M/4, 5m	57	R304956	Protection Magazine 5 pairs, equipped, with arrester without failsafe (FS)	73
R303985	Patch Cord SC-Duplex PC - SC-Duplex PC, OM1, M/4, 1m	57	R304957	Protection Magazine 1 pair, equipped, with arrester with FS plus FS display	73
R303986	Patch Cord SC-Duplex PC - SC-Duplex PC, OM1, M/4, 2m	57	R304958	Protection Magazine 5 pairs, equipped, with arrester with FS plus FS display	73
R303987	Patch Cord SC-Duplex PC - SC-Duplex PC, OM1, M/4, 3m	57	R305014	Patch Cord Cat.5e, U/UTP, 4P, PVC, RJ45/u-RJ45/u, 0.5m	32
R303989	Patch Cord SC-Duplex PC - SC-Duplex PC, OM1, M/4, 5m	57	R305015	Patch Cord Cat.5e, U/UTP, 4P, PVC, RJ45/u-RJ45/u, 1.0m	32
R304073	Mini Breakout Cable I-V(ZN=B)H, OM2, 4-fibers	59	R305019	Patch Cord Cat.5e, U/UTP, 4P, PVC, RJ45/u-RJ45/u, 1.5m	32
R304074	Mini Breakout Cable I-V(ZN=B)H, OM2, 6-fibers	59	R305020	Patch Cord Cat.5e, U/UTP, 4P, PVC, RJ45/u-RJ45/u, 2.0m	32
R304075	Mini Breakout Cable I-V(ZN=B)H, OM2, 8-fibers	59	R305021	Patch Cord Cat.5e, U/UTP, 4P, PVC, RJ45/u-RJ45/u, 3.0m	32
R304076	Mini Breakout Cable I-V(ZN=B)H, OM2, 12-fibers	59	R305022	Patch Cord Cat.5e, U/UTP, 4P, PVC, RJ45/u-RJ45/u, 5.0m	32
R304078	Mini Breakout Cable I-V(ZN=B)H, OM2, 24-fibers	59	R305023	Patch Cord Cat.5e, U/UTP, 4P, PVC, RJ45/u-RJ45/u, 7.5m	32
R304081	Mini Breakout Cable I-V(ZN=B)H, OM1, 4-fibers	59	R305024	Patch Cord Cat.5e, U/UTP, 4P, PVC, RJ45/u-RJ45/u, 10.0m	32
R304082	Mini Breakout Cable I-V(ZN=B)H, OM1, 6-fibers	59	R305025	Patch Cord Cat.5e, U/UTP, 4P, PVC, RJ45/u-RJ45/u, 12.5m	32
R304083	Mini Breakout Cable I-V(ZN=B)H, OM1, 8-fibers	59	R305026	Patch Cord Cat.5e, U/UTP, 4P, PVC, RJ45/u-RJ45/u, 15.0m	32
R304084	Mini Breakout Cable I-V(ZN=B)H, OM1, 12-fibers	59	R305027	Patch Cord Cat.5e, U/UTP, 4P, PVC, RJ45/u-RJ45/u, 20.0m	32
R304086	Mini Breakout Cable I-V(ZN=B)H, OM1, 24-fibers	59	R305039	Patch Cord Cat.5e, SF/UTP, 4P, LSRFRZH, RJ45/s-RJ45/s, 0.5m	32
R304088	Central Loose Tube Cable I/A-DQ(ZN=B)H, OM2, 4-fibers	59	R305040	Patch Cord Cat.5e, SF/UTP, 4P, LSRFRZH, RJ45/s-RJ45/s, 1.0m	32
R304089	Central Loose Tube Cable I/A-DQ(ZN=B)H, OM2, 6-fibers	59	R305041	Patch Cord Cat.5e, SF/UTP, 4P, LSRFRZH, RJ45/s-RJ45/s, 1.5m	32
R304090	Central Loose Tube Cable I/A-DQ(ZN=B)H, OM2, 8-fibers	59	R305042	Patch Cord Cat.5e, SF/UTP, 4P, LSRFRZH, RJ45/s-RJ45/s, 2.0m	32
R304091	Central Loose Tube Cable I/A-DQ(ZN=B)H, OM2, 12-fibers	59	R305043	Patch Cord Cat.5e, SF/UTP, 4P, LSRFRZH, RJ45/s-RJ45/s, 3.0m	32
R304092	Central Loose Tube Cable I/A-DQ(ZN=B)H, OM2, 24-fibers	59	R305044	Patch Cord Cat.5e, SF/UTP, 4P, LSRFRZH, RJ45/s-RJ45/s, 5.0m	32
R304093	Central Loose Tube Cable I/A-DQ(ZN=B)H, OM1, 4-fibers	59	R305045	Patch Cord Cat.5e, SF/UTP, 4P, LSRFRZH, RJ45/s-RJ45/s, 7.5m	32
R304094	Central Loose Tube Cable I/A-DQ(ZN=B)H, OM1, 6-fibers	59	R305046	Patch Cord Cat.5e, SF/UTP, 4P, LSRFRZH, RJ45/s-RJ45/s, 10.0m	32
R304095	Central Loose Tube Cable I/A-DQ(ZN=B)H, OM1, 8-fibers	59	R305047	Patch Cord Cat.5e, SF/UTP, 4P, LSRFRZH, RJ45/s-RJ45/s, 12.5m	32
R304096	Central Loose Tube Cable I/A-DQ(ZN=B)H, OM1, 12-fibers	59	R305048	Patch Cord Cat.5e, SF/UTP, 4P, LSRFRZH, RJ45/s-RJ45/s, 15.0m	32
R304097	Central Loose Tube Cable I/A-DQ(ZN=B)H, OM1, 24-fibers	59	R305049	Patch Cord Cat.5e, SF/UTP, 4P, LSRFRZH, RJ45/s-RJ45/s, 20.0m	32
R304135	Mini Breakout Cable I-V(ZN=B)H, OS1/OS2, 4-fibers	59	R305117	19" 1U PP 24xRJ45/u, Cat.6, Gray	16
R304136	Mini Breakout Cable I-V(ZN=B)H, OS1/OS2, 6-fibers	59	R305118	19" 1U PP 24xRJ45/u, Cat.5e, Gray	16
R304137	Mini Breakout Cable I-V(ZN=B)H, OS1/OS2, 8-fibers	59	R305119	19" 1U PP 24-Port empty, Gray	17
R304138	Mini Breakout Cable I-V(ZN=B)H, OS1/OS2, 12-fibers	59	R305120	19" 1U PP 24xRJ45/s, Real10 Cat.6, Gray	16

Index

Part No	Product	Page No	Part No	Product	Page No
R305121	19" 1U PP 24xRJ45/s, Cat.5e, Gray	17	R306894	19" 1U SpliceBox 12xSC-Duplex, OM2, PC, PhBr, M/4	61
R305150	FM Global Outlet 88x88, 4x1-Port, pure white	36	R307036	FM Connection Box Splash Line IP54, 87x87, 2x1 Port, white	43
R305178	Mechanical Crimp Connectors SC, PC, blue, G.652.D	54	R307037	FM Connection Box Splash Line IP54, 87x87, 1x1 Port, white	43
R305179	Mechanical Crimp Connectors SC, PC, black, OM2	54	R307038	SM Connection Box Splash Line IP54, 87x87, 1x1 Port, white	43
R305180	Mechanical Crimp Connectors SC, PC, beige, OM1	54	R307039	SM Connection Box Splash Line IP54, 87x87, 2x1 Port, white	43
R305181	Mechanical Crimp Connectors ST, PC, blue, G.652.D	54	R307199	Jack Guard	49
R305182	Mechanical Crimp Connectors ST, PC, black, OM2	54	R307231	Patch Cord 1 pair, VS-RJ45 (4/5), 2.0 m	77
R305183	Mechanical Crimp Connectors ST, PC, beige, OM1	54	R307232	Patch Cord 1 pair, VS-RJ45 (3/6), 2.0 m	77
R305208	Label Holder, 25 pairs, 184x25	76	R307299	Pigtail ST, OM2, M/4, 2.5m	57
R305209	Grounding Rail, 25 pairs	73	R307300	Pigtail ST, OM1, M/4, 2.5m	57
R305649	Installation Cable Real10 Cat.6, S/FTP, 4P, 650 MHz, LSZH, 500m	9	R307387	Pigtail ST, OM3, M/4, 2.5m	57
R305685	Hinged Dust Cover, anthracite	47	R307388	Pigtail SC, OM3, M/4, 2.5m	58
R305686	Hinged Dust Cover, blue	47	R307688	FLEXkanal, 1m, light gray	51
R305687	Hinged Dust Cover, brown	47	R307689	FLEXkanal, 1m, white	51
R305688	Hinged Dust Cover, yellow	47	R307690	FLEXkanal, 1m, ultramarine	51
R305689	Hinged Dust Cover, gray	47	R307699	FLEXkanal T-piece, with cable passage	51
R305690	Hinged Dust Cover, green	47	R307700	FLEXkanal Floor Rail, 1m, anthracite	51
R305691	Hinged Dust Cover, red	47	R307701	FLEXkanal Floor Rail, 2m, anthracite	51
R305692	Hinged Dust Cover, violet	47	R307703	FLEXkanal T-piece, anthracite	51
R305693	Hinged Dust Cover, white	47	R307785	3M Dual Lock, qty 2, 25x20mm	46
R305702	Module Holder Flap Jack (Type 6C), 1-Port, jet black	39	R307786	Plastic Base, adhesive, qty 4	46
R305766	Universal Blind Cover, light gray	29	R307791	DESKbox empty, 4x45x45, clear	46
R30581	Patch Cord SC-RJ PC - SC-RJ PC, OM1, M/4, 1m	58	R307792	DESKbox empty, 4x45x45, blue	46
R30582	Patch Cord SC-RJ PC - SC-RJ PC, OM1, M/4, 2m	58	R307793	DESKbox empty, 4x45x45, green	46
R30583	Patch Cord SC-RJ PC - SC-RJ PC, OM1, M/4, 3m	58	R307794	DESKbox empty, 4x45x45, orange	46
R30585	Patch Cord SC-RJ PC - SC-RJ PC, OM1, M/4, 5m	58	R307830	FLEXkanal, 1m, yellow/black gray	51
R305885	19" 1U PP 16xRJ45/s, Cat.5e	15	R307831	FLEXkanal, 1m, yellow	51
R305886	19" 1U PP 16xRJ45/u, Cat.5e	15	R307835	Mounting Plate 22.5x45, 1-Port, white	42
R305887	19" 1U PP 16xRJ45/s, Real10 Cat.6	15	R307837	Mounting Plate 22.5x45, 1-Port, black	42
R305888	19" 1U PP 16xRJ45/u, Cat.6	14	R307960	Faceplate Blind 45x45, white	42
R30591	Patch Cord SC-RJ PC - ST PC, OM1, M/4, 1m	57	R307976	FLEXkanal, 1m, red	51
R30591	Patch Cord ST PC - SC-RJ PC, OM1, M/4, 1m	58	R30805	Adapter SC-Duplex, PC, blue, ceramic SM, C	53
R30592	Patch Cord SC-RJ PC - ST PC, OM1, M/4, 2m	57	R308064	19" 1U SpliceBox 12xSC-Duplex, OM3, PC, PhBr, M/4	61
R30592	Patch Cord ST PC - SC-RJ PC, OM1, M/4, 2m	58	R308066	19" 1U UniRack 12xSC-Duplex, OM3, PC, PhBr, M/4	62
R30593	Patch Cord SC-RJ PC - ST PC, OM1, M/4, 3m	57	R308214	Central Loose Tube Cable I/A-DQ(ZN=B)H, OM3, 12-fibers	59
R30593	Patch Cord ST PC - SC-RJ PC, OM1, M/4, 3m	58	R308215	Central Loose Tube Cable I/A-DQ(ZN=B)H, OM3, 24-fibers	59
R30595	Patch Cord SC-RJ PC - ST PC, OM1, M/4, 5m	57	R308217	Central Loose Tube Cable I/A-DQ(ZN=B)H, OM3, 4-fibers	59
R30595	Patch Cord ST PC - SC-RJ PC, OM1, M/4, 5m	58	R308218	Central Loose Tube Cable I/A-DQ(ZN=B)H, OM3, 8-fibers	59
R306039	Labeling Sheet to 16-Port PP	15	R308247	Installation Cable Real10 Cat.6, U/FTP, 4P, 650 MHz, LSZH, 500m	9
R306057	Splash Mounting Tool, 3-Prong Sleeve Expander	44	R308310	Central Loose Tube Cable I/A-DQ(ZN=B)H, OM3, 6-fibers	59
R306058	Splash Cap IP54, blue	43	R308313	Mini Breakout Cable I-V(ZN=B)H, OM3, 8-fibers	59
R306060	Splash Cap IP54, yellow	43	R308315	Mini Breakout Cable I-V(ZN=B)H, OM3, 4-fibers	59
R306061	Splash Cap IP54, green	43	R308316	Mini Breakout Cable I-V(ZN=B)H, OM3, 6-fibers	59
R306062	Splash Cap IP54, red	43	R308317	Mini Breakout Cable I-V(ZN=B)H, OM3, 24-fibers	59
R306063	Splash Cap IP54, white	43	R308318	Mini Breakout Cable I-V(ZN=B)H, OM3, 12-fibers	59
R306179	19" 1U Cable Management Plastic, 70mm	28	R308444	Splice Tray Additional Set R40	67
R306180	19" 2U Cable Management Plastic, 70mm	28	R308445	Splice Tray Basic Set R40	67
R306181	19" Lateral Radius Guard	29	R308448	Splice Holder R40, splice protection ANT / shrink splice protection	68
R306257	Installation Cable Real10 Cat.7, S/FTP, 4P, 1200 MHz, LSFRZH, 500m	8	R308459	Adapter SC-RJ, PC, black, PhBr MM, N, support plate	53
R30635	Patch Cord ST PC 2x - ST PC 2x, OM2, M/4, 1m	57	R308493	19" 1U UniRack 12xSC-Duplex, OM1, PC, PhBr, M/4	62
R30636	Patch Cord ST PC 2x - ST PC 2x, OM2, M/4, 2m	57	R308495	19" 1U UniRack 12xSC-Duplex, OM2, PC, PhBr, M/4	62
R30637	Patch Cord ST PC 2x - ST PC 2x, OM2, M/4, 3m	57	R308509	19" 1U UniRack 12xLC Duplex, OS1, PC, ceramic, C/2	62
R30639	Patch Cord ST PC 2x - ST PC 2x, OM2, M/4, 5m	57	R308510	19" 1U UniRack 24xLC Duplex, G.652.D, PC, ceramic, C/2	62
R30640	Patch Cord ST PC 2x - ST PC 2x, OM1, M/4, 1m	57	R308513	19" 1U UniRack 12xLC Duplex, OM1, PC, PhBr, M/4	62
R30641	Patch Cord ST PC 2x - ST PC 2x, OM1, M/4, 2m	57	R308514	19" 1U UniRack 24xLC Duplex, OM1, PC, PhBr, M/4	62
R30642	Patch Cord ST PC 2x - ST PC 2x, OM1, M/4, 3m	57	R308515	19" 1U UniRack 12xLC Duplex, OM2, PC, PhBr, M/4	62
R30644	Patch Cord ST PC 2x - ST PC 2x, OM1, M/4, 5m	57	R308516	19" 1U UniRack 24xLC Duplex, OM2, PC, PhBr, M/4	62
R306775	19" 1U SpliceBox / BreakoutBox, cover	61	R308517	19" 1U UniRack 12xLC Duplex, OM3, PC, PhBr, M/4	62
R306876	19" 1U BreakoutBox 12xSC-Duplex, OM1/OM2/OM3, PC, PhBr	53	R308518	19" 1U UniRack 24xLC Duplex, OM3, PC, PhBr, M/4	62
R306879	Adapter SC-Duplex, PC, blue, PhBr SM, D	63	R308708	Snap-in Blind Cover	29
R306884	19" 1U BreakoutBox, unloaded, SC Duplex	63	R30871	Labeling Sheet Fiberliner/3U Global Module Holder	26
R306885	19" 1U BreakoutBox, unloaded, LC Duplex	63	R308731	Connection Module Cat.5e, 100xRJ45/s, Snap-in	5
R306892	19" 1U SpliceBox 12xSC-Duplex, G.652.D, PC, ceramic, C/2	61	R308732	Connection Module Real10 Cat.6, 100xRJ45/s, Snap-in	4
R306893	19" 1U SpliceBox 12xSC-Duplex, OM1, PC, PhBr, M/4	61	R308733	Connection Module Cat.5e, 100xRJ45/u, Snap-in	5

Part No	Product	Page No	Part No	Product	Page No
R308734	Connection Module Cat.6, 100xRJ45/u, Snap-in	4	R310290	Patch Cord LC-Duplex PC - SC-Duplex PC, OM2, M/4, 1m	57
R308886	19" 1U Breakout Box 12xE-2000™ Compact, OM3, PC, PhBr	63	R310290	Patch Cord SC-Duplex PC - LC-Duplex PC, OM2, M/4, 1m	58
R308894	Adapter LC-Duplex, PC, blue, ceramic SM, C	52	R310292	Patch Cord LC-Duplex PC - LC-Duplex PC, OM2, M/4, 1m	58
R308895	Adapter LC-Duplex, PC, blue, PhBr SM, D	52	R310296	Patch Cord LC-Duplex PC - LC-Duplex PC, OM1, M/4, 1m	58
R308896	Adapter LC-Duplex, PC, beige, PhBr MM, N	52	R310400	Voice Adapter 3U Global, 3x10-Port 3 GU	26
R308898	Pigtail LC, OS1, 2.5m	58	R310559	Mechanical Crimp Connectors LC, PC, black, OM2	54
R308900	Pigtail LC, OM1, M/4, 2.5m	58	R310560	Mechanical Crimp Connectors LC, PC, beige, OM1	54
R308901	Pigtail LC, OM2, M/4, 2.5m	58	R310561	Mechanical Crimp Connectors LC, PC, blue, G.652.D	54
R308902	Pigtail LC, OM3, M/4, 2.5m	58	R310694	Adapter No. 1	45
R308903	Patch Cord LC-Duplex PC - LC-Duplex PC, OS1, 2m	58	R310788	FM Global Outlet 88x88, 2x1-Port, pure white	36
R308904	Patch Cord LC-Duplex PC - LC-Duplex PC, OS1, 3m	58	R310835	Plug Reduction Frame RJ45 onto RJ11/RJ12	48
R308905	Patch Cord LC-Duplex PC - LC-Duplex PC, OS1, 5m	58	R310908	Multipair Installation Cable Cat 5e, F/UTP, 25P, LSZH, 300m	12
R308913	Patch Cord LC-Duplex PC - SC-Duplex PC, OS1, 2m	58	R310916	Multipair Installation Cable Cat 5e, U/UTP, 50P, LSZH, 300m	12
R308913	Patch Cord SC-Duplex PC - LC-Duplex PC, OS1, 2m	58	R310917	Multipair Installation Cable Cat 5e, U/UTP, 100P, LSZH, 300m	12
R308914	Patch Cord LC-Duplex PC - SC-Duplex PC, OS1, 3m	58	R310918	Multipair Installation Cable Cat 5e, U/UTP, 25P, LSZH, 300m	12
R308914	Patch Cord SC-Duplex PC - LC-Duplex PC, OS1, 3m	58	R310920	Multipair Installation Cable Cat 5e, F/UTP, 50P, LSZH, 300m	12
R308915	Patch Cord LC-Duplex PC - SC-Duplex PC, OS1, 5m	58	R310921	Multipair Installation Cable Cat 5e, F/UTP, 100P, LSZH, 300m	12
R308915	Patch Cord SC-Duplex PC - LC-Duplex PC, OS1, 5m	58	R311182	DIN Rail Module 2-port, metal	34
R308926	Patch Cord LC-Duplex PC - LC-Duplex PC, OM1, M/4, 2m	58	R311319	Multipair Installation Cable Cat.3, U/UTP, 50P, LSZH, 300m	13
R308927	Patch Cord LC-Duplex PC - LC-Duplex PC, OM1, M/4, 3m	58	R311320	Multipair Installation Cable Cat.3, U/UTP, 100P, LSZH, 300m	13
R308928	Patch Cord LC-Duplex PC - LC-Duplex PC, OM1, M/4, 5m	58	R311321	Multipair Installation Cable Cat.3, F/UTP, 25P, LSZH, 300m	13
R308932	Patch Cord LC-Duplex PC - SC-RJ PC, OM1, M/4, 2m	58	R311322	Multipair Installation Cable Cat.3, U/UTP, 25P, LSZH, 300m	13
R308932	Patch Cord SC-RJ PC - LC-Duplex PC, OM1, M/4, 2m	58	R311323	Multipair Installation Cable Cat.3, F/UTP, 50P, LSZH, 300m	13
R308933	Patch Cord LC-Duplex PC - SC-RJ PC, OM1, M/4, 3m	58	R311324	Multipair Installation Cable Cat.3, F/UTP, 100P, LSZH, 300m	13
R308933	Patch Cord SC-RJ PC - LC-Duplex PC, OM1, M/4, 3m	58	R311387	Central Loose Tube Cable A-DQ(ZN)B2Y, OM3, 12-fibers	59
R308934	Patch Cord LC-Duplex PC - SC-RJ PC, OM1, M/4, 5m	58	R311388	Central Loose Tube Cable A-DQ(ZN)B2Y, OM3, 24-fibers	59
R308934	Patch Cord SC-RJ PC - LC-Duplex PC, OM1, M/4, 5m	58	R311390	Central Loose Tube Cable A-D(ZN)W2Y, OM3, 12-fibers	59
R308935	Patch Cord LC-Duplex PC - SC-Duplex PC, OM1, M/4, 2m	57	R311391	Central Loose Tube Cable A-D(ZN)W2Y, OM3, 24-fibers	59
R308935	Patch Cord SC-Duplex PC - LC-Duplex PC, OM1, M/4, 2m	58	R311392	Stranded Loose Tube Cables A-DF(ZN)Y2Y2Y, OM3, 4x12-fibers	59
R308936	Patch Cord LC-Duplex PC - SC-Duplex PC, OM1, M/4, 3m	57	R311561	FM45 Color Coding Clip, anthracite	48
R308936	Patch Cord SC-Duplex PC - LC-Duplex PC, OM1, M/4, 3m	58	R311569	FM45 Color Coding Clip, brown	48
R308937	Patch Cord LC-Duplex PC - SC-Duplex PC, OM1, M/4, 5m	57	R311570	FM45 Color Coding Clip, gray	48
R308937	Patch Cord SC-Duplex PC - LC-Duplex PC, OM1, M/4, 5m	58	R311571	FM45 Color Coding Clip, red	48
R308938	Patch Cord LC-Duplex PC - LC-Duplex PC, OM2, M/4, 2m	58	R311575	FM45 Color Coding Clip, violet	48
R308939	Patch Cord LC-Duplex PC - LC-Duplex PC, OM2, M/4, 3m	58	R311577	FM45 Color Coding Clip, green	48
R308940	Patch Cord LC-Duplex PC - LC-Duplex PC, OM2, M/4, 5m	58	R311579	FM45 Color Coding Clip, yellow	48
R308944	Patch Cord LC-Duplex PC - SC-RJ PC, OM2, M/4, 2m	58	R311580	FM45 Color Coding Clip, blue	48
R308944	Patch Cord SC-RJ PC - LC-Duplex PC, OM2, M/4, 2m	58	R311928	Patch Cord Cat.6, U/UTP, 4P, LSZH, RJ45/u-RJ45/u, 1.0m, red	30
R308945	Patch Cord LC-Duplex PC - SC-RJ PC, OM2, M/4, 3m	58	R311932	Patch Cord Cat.6, U/UTP, 4P, LSZH, RJ45/u-RJ45/u, 2.0m, red	30
R308945	Patch Cord SC-RJ PC - LC-Duplex PC, OM2, M/4, 3m	58	R311933	Patch Cord Cat.6, U/UTP, 4P, LSZH, RJ45/u-RJ45/u, 3.0m, red	30
R308946	Patch Cord LC-Duplex PC - SC-RJ PC, OM2, M/4, 5m	58	R311934	Patch Cord Cat.6, U/UTP, 4P, LSZH, RJ45/u-RJ45/u, 5.0m, red	30
R308946	Patch Cord SC-RJ PC - LC-Duplex PC, OM2, M/4, 5m	58	R311935	Patch Cord Cat.6, U/UTP, 4P, LSZH, RJ45/u-RJ45/u, 1.0m, yellow	30
R308947	Patch Cord LC-Duplex PC - SC-Duplex PC, OM2, M/4, 2m	57	R311936	Patch Cord Cat.6, U/UTP, 4P, LSZH, RJ45/u-RJ45/u, 3.0m, yellow	30
R308947	Patch Cord SC-Duplex PC - LC-Duplex PC, OM2, M/4, 2m	58	R311937	Patch Cord Cat.6, U/UTP, 4P, LSZH, RJ45/u-RJ45/u, 5.0m, yellow	30
R308948	Patch Cord LC-Duplex PC - SC-Duplex PC, OM2, M/4, 3m	57	R311938	Patch Cord Cat.6, U/UTP, 4P, LSZH, RJ45/u-RJ45/u, 1.0m, blue	30
R308948	Patch Cord SC-Duplex PC - LC-Duplex PC, OM2, M/4, 3m	58	R311939	Patch Cord Cat.6, U/UTP, 4P, LSZH, RJ45/u-RJ45/u, 3.0m, blue	30
R308949	Patch Cord LC-Duplex PC - SC-Duplex PC, OM2, M/4, 5m	57	R311940	Patch Cord Cat.6, U/UTP, 4P, LSZH, RJ45/u-RJ45/u, 5.0m, blue	30
R308949	Patch Cord SC-Duplex PC - LC-Duplex PC, OM2, M/4, 5m	58	R311941	Patch Cord Cat.6, U/UTP, 4P, LSZH, RJ45/u-RJ45/u, 1.0m, green	30
R308959	Patch Cord LC-Duplex PC - SC-Duplex PC, OM3, M/4, 2m	58	R311942	Patch Cord Cat.6, U/UTP, 4P, LSZH, RJ45/u-RJ45/u, 3.0m, green	30
R308960	Patch Cord LC-Duplex PC - SC-Duplex PC, OM3, M/4, 3m	58	R311943	Patch Cord Cat.6, U/UTP, 4P, LSZH, RJ45/u-RJ45/u, 5.0m, green	30
R308961	Patch Cord LC-Duplex PC - SC-Duplex PC, OM3, M/4, 5m	58	R312231	FM45 Connector IP20, 4P, TIA 568A	7
R308971	Compact Housing, 6x1-Port, pure white	35	R312767	Cable Passage Ø 95 with FLEXkanal Link, anthracite	51
R309022	Adapter Collar	44	R312789	Central Loose Tube Cable A-DQ(ZN)B2Y, OM1, 6-fibers	59
R309170	Faceplate Blind 45x45, black	42	R312791	Central Loose Tube Cable A-DQ(ZN)B2Y, OM2, 6-fibers	59
R309319	Installation Cable Cat.5e, S/FTP, 4P, 200 MHz, LSFRZH, 500m	10	R312792	Central Loose Tube Cable A-DQ(ZN)B2Y, OM3, 6-fibers	59
R309571	DESKbox empty, 4x45x45, anthracite	46	R312793	Central Loose Tube Cable A-D(ZN)W2Y, OS1/OS2, 6-fibers	59
R309588	Mounting Frame IP67 Interbus, plastic	56	R312794	Central Loose Tube Cable A-D(ZN)W2Y, OM3, 6-fibers	59
R309589	Protective Cover IP67 Interbus	56	R312795	Central Loose Tube Cable A-D(ZN)W2Y, OM2, 6-fibers	59
R31014	Pigtail SC, OS1, 2.5m	58	R312796	Central Loose Tube Cable A-D(ZN)W2Y, OM1, 6-fibers	59
R310218	Fiber Guard SC-RJ Adapter	69	R312797	Central Loose Tube Cable A-DQ(ZN)B2Y, OS1/OS2, 6-fibers	59
R310262	Color Coding Interbus IP67 Mounting Frame	69	R312986	Patch Cord LC-Duplex PC - ST PC, OM2, M/4, 2m	57
R310284	Patch Cord LC-Duplex PC - LC-Duplex PC, OS1, 1m	58	R312986	Patch Cord ST PC - LC-Duplex PC, OM2, M/4, 2m	58
R310289	Patch Cord LC-Duplex PC - SC-RJ PC, OM2, M/4, 1m	58	R313027	Patch Cord SC-Duplex PC - SC-Duplex PC, OS1, 1m	58
R310289	Patch Cord SC-RJ PC - LC-Duplex PC, OM2, M/4, 1m	58	R313047	19" 1U PP 24xRJ45/s, Real10 Cat.6, Black	16

Index

Part No	Product	Page No	Part No	Product	Page No
R313048	19" 1U PP 24xRJ45/s, Cat.5e, Black	17	R314549	Stranded Loose Tube Cables A-DF(ZN)2YW2Y, OM2, 2x12-fibers	59
R313064	Connection Module Real10 Cat.6, 1xRJ45/u	3	R314550	Stranded Loose Tube Cables A-DF(ZN)2YW2Y, OM2, 6x12-fibers	59
R313083	Connection Module Real10 Cat.6, 100xRJ45/u	3	R314551	Stranded Loose Tube Cables A-DF(ZN)2YW2Y, OM2, 8x12-fibers	59
R313086	19" 1U PP 16xRJ45/u, Real10 Cat.6	14	R314552	Stranded Loose Tube Cables A-DF(ZN)2YW2Y, OM3, 1x12-fibers	59
R313087	19" 1U PP 24xRJ45/u, Real10 Cat.6	16	R314553	Stranded Loose Tube Cables A-DF(ZN)2YW2Y, OM3, 2x12-fibers	59
R313088	19" 3U Global PP 48xRJ45/u, Real10 Cat.6	23	R314554	Stranded Loose Tube Cables A-DF(ZN)2YW2Y, OM3, 6x12-fibers	59
R313089	19" 3U Global PP 60xRJ45/u, Real10 Cat.6	24	R314555	Stranded Loose Tube Cables A-DF(ZN)2YW2Y, OM3, 8x12-fibers	59
R313090	Connection Module Real10 Cat.6, 1xRJ45/u, Snap-in	4	R314556	Stranded Loose Tube Cables A-DF(ZN)2YW2Y, OS1/OS2, 1x12-fibers	59
R313136	Patch Cord LC-Duplex PC - ST PC, OM2, M/4, 3m	57	R314557	Stranded Loose Tube Cables A-DF(ZN)2YW2Y, OS1/OS2, 2x12-fibers	59
R313136	Patch Cord ST PC - LC-Duplex PC, OM2, M/4, 3m	58	R314558	Stranded Loose Tube Cables A-DF(ZN)2YW2Y, OS1/OS2, 6x12-fibers	59
R313152	Pigtail ST, OS1, 2.5m	57	R314559	Stranded Loose Tube Cables A-DF(ZN)2YW2Y, OS1/OS2, 8x12-fibers	59
R313330	Mounting Plate 45x45, 2x1-Port, pure white	42	R314762	Patch Cord Cat.6, U/UTP, 4P, LSZH, RJ45/u-RJ45/u, 10.0m, yellow	30
R313331	Angled Mounting Plate 45x45, 2x1-Port, jet black	42	R314914	Patch Cord Cat.6, U/UTP, 4P, LSZH, RJ45/u-RJ45/u, 1.5m, yellow	30
R313332	Angled Mounting Plate 45x45, 2x1-Port, pure white	42	R314915	Patch Cord Cat.6, U/UTP, 4P, LSZH, RJ45/u-RJ45/u, 0.5m, yellow	30
R313333	Mounting Plate 45x45, 2x1-Port, jet black	42	R315541	Patch Cord Cat.6, U/UTP, 4P, LSZH, RJ45/u-RJ45/u, 1.5m, red	30
R313410	Patch Cord LC-Duplex PC - SC-Duplex PC, OS1, 10m	58	R316064	Patch Cord Cat.6, U/UTP, 4P, LSZH, RJ45/u-RJ45/u, 7.5m, blue	30
R313410	Patch Cord SC-Duplex PC - LC-Duplex PC, OS1, 10m	58	R316247	Global Cable Management, 3-Ring, 70mm, Plastic	29
R313412	Patch Cord LC-Duplex PC - LC-Duplex PC, OS1, 10m	58	R316612	Connector Kit LC, PC, MM, beige, M, 127, 2.1mm cable, black	55
R313414	Patch Cord SC-Duplex PC - SC-Duplex PC, OS1, 10m	58	R316618	Connector Kit ST, PC, MM, M, 127, 2.1mm cable, black	55
R313632	Patch Cord Real10 Cat.6, S/FTP, 4P, PUR, RJ45/s-RJ45/s, 10.0m	33	R316648	Patch Cord Cat.6, U/UTP, 4P, LSZH, RJ45/u-RJ45/u, 7.5m, red	30
R313633	Patch Cord Real10 Cat.6, S/FTP, 4P, PUR, RJ45/s-RJ45/s, 2.5m	33	R316871	Blind Cover 2U Global	22
R313634	Patch Cord Real10 Cat.6, S/FTP, 4P, PUR, RJ45/s-RJ45/s, 5.0m	33	R317004	Patch Cord Cat.6, U/UTP, 4P, LSZH, RJ45/u-RJ45/u, 1.5m, blue	30
R313635	Patch Cord Real10 Cat.6, S/FTP, 4P, PUR, RJ45/s-RJ45/s, 7.5m	33	R317093	Easy Latch, violet	47
R313636	Patch Cord Real10 Cat.6, S/FTP, 4P, PUR, RJ45/s-RJ45/s IP67, 10.0m	33	R317094	Easy Latch, blue	47
R313637	Patch Cord Real10 Cat.6, S/FTP, 4P, PUR, RJ45/s-RJ45/s IP67, 2.5m	33	R317095	Easy Latch, brown	47
R313638	Patch Cord Real10 Cat.6, S/FTP, 4P, PUR, RJ45/s-RJ45/s IP67, 5.0m	33	R317096	Easy Latch, yellow	47
R313639	Patch Cord Real10 Cat.6, S/FTP, 4P, PUR, RJ45/s-RJ45/s IP67, 7.5m	33	R317097	Easy Latch, gray	47
R313640	Patch Cord Real10 Cat.6, S/FTP, 4P, PUR, RJ45/s-RJ45/s IP67, 10.0m	33	R317098	Easy Latch, green	47
R313641	Patch Cord Real10 Cat.6, S/FTP, 4P, PUR, RJ45/s-RJ45/s IP67, 2.5m	33	R317099	Easy Latch, red	47
R313642	Patch Cord Real10 Cat.6, S/FTP, 4P, PUR, RJ45/s-RJ45/s IP67, 5.0m	33	R317100	Easy Latch, anthracite	47
R313643	Patch Cord Real10 Cat.6, S/FTP, 4P, PUR, RJ45/s-RJ45/s IP67, 7.5m	33	R317149	Connector Kit LC, PC, SM, blue, C, 126, 2.1mm cable, blue	55
R313814	Patch Guard RJ45	50	R317151	Connector Kit ST, PC, SM, M, 126, 2.8mm cable, blue	55
R313815	Key Patch Guard RJ45	50	R317153	Connector Kit ST, PC, SM, M, 126, 2.1mm cable, blue	55
R313866	Patch Cord Cat.6, U/UTP, 4P, LSZH, RJ45/u-RJ45/u, 2.0m, yellow	30	R317209	Patch Cord Cat.6, U/UTP, 4P, LSZH, RJ45/u-RJ45/u, 20.0m, green	30
R313869	Patch Cord Cat.6, U/UTP, 4P, LSZH, RJ45/u-RJ45/u, 10.0m, blue	30	R317210	Patch Cord Cat.6, U/UTP, 4P, LSZH, RJ45/u-RJ45/u, 20.0m, blue	30
R313872	Patch Cord Cat.6, U/UTP, 4P, LSZH, RJ45/u-RJ45/u, 10.0m, green	30	R317211	Patch Cord Cat.6, U/UTP, 4P, LSZH, RJ45/u-RJ45/u, 1.5m, green	30
R313969	Patch Cord Cat.6, U/UTP, 4P, LSZH, RJ45/u-RJ45/u, 2.0m, blue	30	R317254	Patch Cord Cat.6, U/UTP, 4P, LSZH, RJ45/u-RJ45/u, 0.5m, green	30
R313970	Patch Cord Cat.6, U/UTP, 4P, LSZH, RJ45/u-RJ45/u, 2.0m, green	30	R317255	Patch Cord Cat.6, U/UTP, 4P, LSZH, RJ45/u-RJ45/u, 0.5m, blue	30
R314000	DIN Rail Module DRM45, plastic	34	R318169	Patch Cord LC-Duplex PC - SC-Duplex PC, OM1, M/4, 10m	57
R314347	19" 1U BreakoutBox 12xLC-Duplex, OM1/OM2/OM3, PC, PhBr	63	R318169	Patch Cord SC-Duplex PC - LC-Duplex PC, OM1, M/4, 10m	58
R314447	Mechanical Crimp Connectors LC, PC, turquoise, OM3	54	R318269	Adapter SC-RJ, Adapter SC-RJ PC, blue, PhBr SM, D, support plate	53
R314448	Mechanical Crimp Connectors SC, PC, turquoise, OM3	54	R318666	Patch Cord SC-RJ IP67 PC - SC-RJ IP67 PC, OM2, M/4, 20m	56
R314449	Mechanical Crimp Connectors ST, PC, turquoise, OM3	54	R318736	Universal Adapter SC, SM, ceramic, blue, D	53
R314455	Central Loose Tube Cable A-D(ZN)W2Y, OM1, 8-fibers	59	R318737	Universal Adapter SC, MM, PhBr, beige, M	53
R314456	Central Loose Tube Cable A-D(ZN)W2Y, OM2, 8-fibers	59	R318738	Universal Adapter LC-Duplex, SM, ceramic, blue, D	52
R314457	Central Loose Tube Cable A-D(ZN)W2Y, OM3, 8-fibers	59	R318739	Universal Adapter LC-Duplex, MM, PhBr, beige, M	52
R314486	Mini Breakout Cable I-V(ZN=B)H, OM1, 2-fibers	59	R319024	Color Coding RMS45, blue	48
R314488	Mini Breakout Cable I-V(ZN=B)H, OM2, 2-fibers	59	R319025	Color Coding RMS45, brown	48
R314490	Mini Breakout Cable I-V(ZN=B)H, OM3, 2-fibers	59	R319026	Color Coding RMS45, yellow	48
R314492	Mini Breakout Cable I-V(ZN=B)H, OS1/OS2, 2-fibers	59	R319027	Color Coding RMS45, gray	48
R314519	Central Loose Tube Cable A-DQ(ZN)B2Y, OM1, 4-fibers	59	R319028	Color Coding RMS45, green	48
R314520	Central Loose Tube Cable A-DQ(ZN)B2Y, OM1, 8-fibers	59	R319029	Color Coding RMS45, red	48
R314521	Central Loose Tube Cable A-DQ(ZN)B2Y, OM2, 4-fibers	59	R319030	Color Coding RMS45, violet	48
R314522	Central Loose Tube Cable A-DQ(ZN)B2Y, OM2, 8-fibers	59	R319031	Color Coding RMS45, anthracite	48
R314523	Central Loose Tube Cable A-DQ(ZN)B2Y, OM3, 4-fibers	59	R319034	RMS45 Microsplitter Insert, shielded	6
R314524	Central Loose Tube Cable A-DQ(ZN)B2Y, OM3, 8-fibers	59	R319035	RMS45 Plug 1-Pair, unshielded	6
R314525	Central Loose Tube Cable A-DQ(ZN)B2Y, OS1/OS2, 4-fibers	59	R319036	RMS45 Plug 2-Pair, shielded	6
R314526	Central Loose Tube Cable A-DQ(ZN)B2Y, OS1/OS2, 8-fibers	59	R319057	Adapter Cord Cat.5e, SF/UTP, 2P, LSFRZH, RMS45-RJ45/s (4-5, 3-6), 1.0m	6
R314543	Central Loose Tube Cable A-D(ZN)W2Y, OS1/OS2, 8-fibers	59	R319058	Adapter Cord Cat.5e, SF/UTP, 2P, LSFRZH, RMS45-RJ45/s (4-5, 3-6), 2.0m	6
R314544	Stranded Loose Tube Cables A-DF(ZN)2YW2Y, OM1, 1x12-fibers	59	R319059	Adapter Cord Cat.5e, SF/UTP, 2P, LSFRZH, RMS45-RJ45/s (4-5, 3-6), 3.0m	6
R314545	Stranded Loose Tube Cables A-DF(ZN)2YW2Y, OM1, 2x12-fibers	59	R319060	Adapter Cord Cat.5e, SF/UTP, 2P, LSFRZH, RMS45-RJ45/s (4-5, 3-6), 5.0m	6
R314546	Stranded Loose Tube Cables A-DF(ZN)2YW2Y, OM1, 6x12-fibers	59	R319212	Heat Shrink Splice Protection, 3x45 mm	68
R314547	Stranded Loose Tube Cables A-DF(ZN)2YW2Y, OM1, 8x12-fibers	59	R319522	Installation Cable Real10 Cat.7, S/FTP, 4P, 1000 MHz, LSFRZH, 500m	8
R314548	Stranded Loose Tube Cables A-DF(ZN)2YW2Y, OM2, 1x12-fibers	59	R320153	Patch Cord ST PC 2x - ST PC 2x, OS1, 2m	57

Part No	Product	Page No	Part No	Product	Page No
R320374	FM45 Connector IP20, 4P, TIA 568B	7	R503228	Global Cable Management, 2-Ring, 70mm, Metal	29
R320375	FM45 IP65 - IP67, 4P, TIA 568A	7	R503380	Labeling Sheet 2U Global	22
R320376	FM45 IP65 - IP67, 4P, TIA 568B	7	R503805	19" 2U Global PP 48-Port/u empty	21
R320385	Splash Sleeve IP54, transparent	44	R503806	19" 2U Global PP 48-Port/s empty	21
R320691	FM45 Connector Housing IP67 Interbus	7	R503813	Connection Module Holder 2U Global/s	22
R321112	Patch Cord Cat.6, U/UTP, 4P, LSZH, RJ45/u-RJ45/u, 7.5m, green	30	R503814	19" 1U PP BASIC Cat.6 24XRJ45/u, Gray	17
R321244	Patch Cord Cat.6, U/UTP, 4P, LSZH, RJ45/u-RJ45/u, 0.5m, red	30	R504252	Installation Cable Real10 Cat.6A, U/UTP, 4P, 650 MHz, LSZH, 305m	9
R321604	19" 1U PP 24xRJ45/u, Cat.5e, Black	16	R504610	Connection Module Holder 2U Global/u	22
R321605	19" 1U PP 24xRJ45/u, Cat.6, Black	16	R505559	19" 1U UniRack 24xLC Duplex, unloaded	62
R322650	Patch Cord Cat.6, U/UTP, 4P, LSZH, RJ45/u-RJ45/u, 10.0m, red	30	R505715	19" 2U Global PP 48xRJ45/s, Cat.5e	21
R323040	Patch Cord ST PC 2x - ST PC 2x, OM3, M/4, 2m	57	R505716	19" 2U Global PP 48xRJ45/u, Cat.5e	21
R323041	Patch Cord ST PC 2x - ST PC 2x, OM3, M/4, 3m	57	R505718	19" 2U Global PP 48xRJ45/u, Cat.6	20
R323042	Patch Cord ST PC 2x - ST PC 2x, OM3, M/4, 5m	57	R505719	19" 2U Global PP 48xRJ45/s, Real10 Cat.6	20
R323045	Patch Cord SC-Duplex PC - SC-Duplex PC, OM3, M/4, 3m	58	R505720	19" 2U Global PP 48xRJ45/u, Real10 Cat.6	20
R323046	Patch Cord SC-Duplex PC - SC-Duplex PC, OM3, M/4, 5m	58	R505851	Global Cable Management, 2-Ring, 70mm, Plastic	29
R323059	Patch Cord LC-Duplex PC - SC-Duplex PC, OM3, M/4, 1m	58	R506796	19" 1U Angled PP 24-Port empty	19
R323059	Patch Cord SC-Duplex PC - LC-Duplex PC, OM3, M/4, 1m	58	R506971	Connector Kit LC, PC, SM, blue, C, 126, 0.9mm tube, blue	55
R323060	Patch Cord SC-Duplex PC - LC-Duplex PC, OM3, M/4, 2m	58	R506989	Connector Kit LC, PC, MM, beige, M, 127, 0.9mm tube, beige	55
R323060	Patch Cord LC-Duplex PC - LC-Duplex PC, OM3, M/4, 2m	58	R506993	Connector Kit ST, PC, MM, M, 127, 0.9mm tube, black	55
R323061	Patch Cord SC-Duplex PC - LC-Duplex PC, OM3, M/4, 3m	58	R507032	Installation Cable Real10 Cat.7, S/FTP, 4P, 1500 MHz, LSFRZH, 500m	8
R323061	Patch Cord LC-Duplex PC - LC-Duplex PC, OM3, M/4, 3m	58	R509500	Connection Module Cat.6A ISO, RJ45/u, 10x	1
R323062	Patch Cord SC-Duplex PC - LC-Duplex PC, OM3, M/4, 5m	58	R509501	Connection Module Cat.6A ISO, RJ45/u, 100x	1
R323062	Patch Cord LC-Duplex PC - LC-Duplex PC, OM3, M/4, 5m	58	R509502	Connection Module Cat.6A ISO, RJ45/u, Snap-in, 10x	1
R323063	Patch Cord LC-Duplex PC - LC-Duplex PC, OM3, M/4, 1m	58	R509503	Connection Module Cat.6A ISO, RJ45/u, Snap-in, 100x	1
R323074	Patch Cord SC-Duplex PC - SC-Duplex PC, OM3, M/4, 2m	58	R509504	Connection Module Cat.6A ISO, RJ45/s, 10x	1
R323111	Patch Cord LC-Duplex PC - LC-Duplex PC, OM3, M/4, 10m	58	R509505	Connection Module Cat.6A ISO, RJ45/s, 100x	1
R35044	Installation Cable Cat.5e, U/UTP, 4P, 200 MHz, PVC, 500m	11	R509506	Connection Module Cat.6A ISO, RJ45/s, Snap-in, 10x	1
R35045	Installation Cable Cat.5e, U/UTP, 4P, 200 MHz, LSZH, 500m	11	R509507	Connection Module Cat.6A ISO, RJ45/s, Snap-in, 100x	1
R35049	Installation Cable Cat.5e, F/UTP, 4P, 200 MHz, LSZH, 500m	11	R509508	Connection Module Cat.6A ISO, 1xRJ45/u, Keystone, 10x	2
R35052	Installation Cable Cat.5e, SF/UTP, 4P, 200 MHz, PVC, 500m	11	R509509	Connection Module Cat.6A ISO, 1xRJ45/s, Keystone, 10x	2
R35053	Installation Cable Cat.5e, SF/UTP, 4P, 200 MHz, LSFRZH, 500m	11	R509857	Patch Cord Cat.6A ISO, S/FTP, 4P, LSFRZH, RJ45/s-RJ45/s, 0.5m	31
R35056	Installation Cable Cat.6, U/UTP, 4P, 450 MHz, PVC, 500m	9	R509858	Patch Cord Cat.6A ISO, S/FTP, 4P, LSFRZH, RJ45/s-RJ45/s, 1.0m	31
R35057	Installation Cable Cat.6, U/UTP, 4P, 450 MHz, LSZH, 500m	9	R509860	Patch Cord Cat.6A ISO, S/FTP, 4P, LSFRZH, RJ45/s-RJ45/s, 1.5m	31
R35060	Installation Cable Real10 Cat.7, S/FTP, 4P, 900 MHz, LSFRZH, 500m	8	R509861	Patch Cord Cat.6A ISO, S/FTP, 4P, LSFRZH, RJ45/s-RJ45/s, 2.0m	31
R35115	19" 1U PP 50-Port, empty	27	R509862	Patch Cord Cat.6A ISO, S/FTP, 4P, LSFRZH, RJ45/s-RJ45/s, 3.0m	31
R35116	Connection Module 10xRJ45/u (4-5, 3-6)	27	R509863	Patch Cord Cat.6A ISO, S/FTP, 4P, LSFRZH, RJ45/s-RJ45/s, 5.0m	31
R35117	Blind Cover 1x10-Port, light gray	27	R509864	Patch Cord Cat.6A ISO, S/FTP, 4P, LSFRZH, RJ45/s-RJ45/s, 7.5m	31
R35257	Installation Cable Real10 Cat.7, S/FTP, 4P, 750 MHz, LSZH, 500m	8	R509865	Patch Cord Cat.6A ISO, S/FTP, 4P, LSFRZH, RJ45/s-RJ45/s, 10.0m	31
R35291	Installation Cable Cat.5e, U/UTP, 4P, 200 MHz, PVC, 305m	11	R509866	Patch Cord Cat.6A ISO, S/FTP, 4P, LSFRZH, RJ45/s-RJ45/s, 12.5m	31
R35292	Installation Cable Cat.5e, U/UTP, 4P, 200 MHz, LSZH, 305m	11	R509867	Patch Cord Cat.6A ISO, S/FTP, 4P, LSFRZH, RJ45/s-RJ45/s, 15.0m	31
R35401	Blind Cover 3U Global, 1 GU	26	R509868	Patch Cord Cat.6A ISO, S/FTP, 4P, LSFRZH, RJ45/s-RJ45/s, 20.0m	31
R35402	Connection Module Holder 3U Global/s	26	R509869	Patch Cord Cat.6A ISO, U/UTP, 4P, LSFRZH, RJ45/u-RJ45/u, 0.5m	31
R35403	Connection Module Holder 3U Global/u	26	R509870	Patch Cord Cat.6A ISO, U/UTP, 4P, LSFRZH, RJ45/u-RJ45/u, 1.0m	31
R35404	19" 3U Global PP 48xRJ45/s, Cat.5e	24	R509871	Patch Cord Cat.6A ISO, U/UTP, 4P, LSFRZH, RJ45/u-RJ45/u, 1.5m	31
R35405	19" 3U Global PP 48xRJ45/u, Cat.5e	24	R509872	Patch Cord Cat.6A ISO, U/UTP, 4P, LSFRZH, RJ45/u-RJ45/u, 2.0m	31
R35406	19" 3U Global PP 60xRJ45/s, Cat.5e	25	R509873	Patch Cord Cat.6A ISO, U/UTP, 4P, LSFRZH, RJ45/u-RJ45/u, 3.0m	31
R35407	19" 3U Global PP 60xRJ45/u, Cat.5e	25	R509874	Patch Cord Cat.6A ISO, U/UTP, 4P, LSFRZH, RJ45/u-RJ45/u, 5.0m	31
R35408	19" 3U Global PP 60-Port/s	25	R509875	Patch Cord Cat.6A ISO, U/UTP, 4P, LSFRZH, RJ45/u-RJ45/u, 7.5m	31
R35409	19" 3U Global PP 60-Port/u	25	R509876	Patch Cord Cat.6A ISO, U/UTP, 4P, LSFRZH, RJ45/u-RJ45/u, 10.0m	31
R500078	Adapter LC-Duplex PC (for security), beige/beige-non, PhBr, MM, N	52	R509877	Patch Cord Cat.6A ISO, U/UTP, 4P, LSFRZH, RJ45/u-RJ45/u, 12.5m	31
R500170	Adapter LC-Duplex PC (for security), blue/blue-non, PhBr SM, D	52	R509878	Patch Cord Cat.6A ISO, U/UTP, 4P, LSFRZH, RJ45/u-RJ45/u, 15.0m	31
R500220	Adapter LC-Duplex PC (for security), blue/blue-non, ceramic SM, C	52	R509879	Patch Cord Cat.6A ISO, U/UTP, 4P, LSFRZH, RJ45/u-RJ45/u, 20.0m	31
R500520	19" 1U Angled PP 24xRJ45/u, Cat.5e	18	R510833	Parallel pliers, 10x	2
R500524	19" 1U Angled PP 24xRJ45/s, Cat.5e	19	R510838	US Style Faceplate 72x117.5, 2x1-Port, pure white	41
R500532	19" 1U Angled PP 24xRJ45/u, Cat.6	18	R510839	503 Outlet 118x72, 2x1-Port, pure white	37
R500536	19" 1U Angled PP 24xRJ45/u, Real10 Cat.6	18	R510854	Port Guard	50
R500539	19" 1U Angled PP 24xRJ45/s, Real10 Cat.6	18	R510856	19" 1U MPO Panel, 8xMTPm - 24xLC-Quad, OM3, PC/PC, gray	65
R502272	19" 1U Cable Management Metal, 70mm	29	R510857	19" 1U MPO Panel, 8xMTPm - 24xLC-Quad, OM3, PC/PC, black	65
R502280	19" 1U Cable Management Metal, 90mm	29	R511914	Trunk Cable, 12 fibers, 12MTPf PC - 12MTPf PC, OM3, LSZH, 10m	66
R502281	19" 2U Cable Management Metal, 70mm	28	R511915	Trunk Cable, 12 fibers, 12MTPf PC - 12MTPf PC, OM3, LSZH, 20m	66
R502282	19" 2U Cable Management Metal, 90mm	28	R511917	Trunk Cable, 12 fibers, 12MTPf PC - 12MTPf PC, OM4, LSZH, 10m	66
R502913	19" 1U Angled PP, Cover	19	R511918	Trunk Cable, 12 fibers, 12MTPf PC - 12MTPf PC, OM4, LSZH, 20m	66
R503071	19" 1U PP 24-Port BASIC empty	17	R511929	Harness Cable, 12 fibers, 12MTPm PC - LC PC 12x, OM3, LSZH, 10m	66
R503227	Global Cable Management, 3-Ring, 70mm, Metal	29	R511930	Harness Cable, 12 fibers, 12MTPm PC - LC PC 12x, OM3, LSZH, 20m	66

Index

Part No	Product	Page No	Part No	Product	Page No
R511932	Harness Cable, 12 fibers, 12MTPm PC - LC PC 12x, OM4, LSZH, 10m	66	R800288	Patch Cord ST PC - LC-Duplex PC, OM1, M/4, 10m	58
R511933	Harness Cable, 12 fibers, 12MTPm PC - LC PC 12x, OM4, LSZH, 20m	66	R800289	Patch Cord LC-Duplex PC - ST PC, OM2, M/4, 1m	57
R511996	19" 1U PP 24-Port empty, Black	17	R800289	Patch Cord ST PC - LC-Duplex PC, OM2, M/4, 1m	58
R511998	Connection Module Cat.6A ISO, RJ45/u, Snap-in, 24x, Black	1	R800290	Patch Cord LC-Duplex PC - ST PC, OM2, M/4, 5m	57
R511999	Connection Module Cat.6A ISO, RJ45/s, Snap-in, 24x, Black	1	R800290	Patch Cord ST PC - LC-Duplex PC, OM2, M/4, 5m	58
R512369	Connection Module Cat.6, 24xRJ45/u, Snap-in, Black	4	R800291	Patch Cord LC-Duplex PC - ST PC, OM2, M/4, 10m	57
R512370	Connection Module Real10 Cat.6, 24xRJ45/s, Snap-in, Black	4	R800291	Patch Cord ST PC - LC-Duplex PC, OM2, M/4, 10m	58
R512383	MPO Modul 7HP, metal, 2xMTPm - 12xLC-Duplex, OM3, PC/PC, ceramic	64	R800292	Patch Cord LC-Duplex PC - ST PC, OM3, M/4, 1m	57
R512390	MPO Modul 7HP, metal, 2xMTPm - 6xLC-Quad, OM3, PC/PC, ceramic	64	R800292	Patch Cord ST PC - LC-Duplex PC, OM3, M/4, 1m	58
R512391	Central Loose Tube Cable I/A-DQ(ZN=B)H, OM4, 4-fibers	59	R800293	Patch Cord LC-Duplex PC - ST PC, OM3, M/4, 10m	57
R512392	Central Loose Tube Cable I/A-DQ(ZN=B)H, OM4, 6-fibers	59	R800293	Patch Cord ST PC - LC-Duplex PC, OM3, M/4, 10m	58
R512393	Central Loose Tube Cable I/A-DQ(ZN=B)H, OM4, 8-fibers	59	R800294	Patch Cord LC-Duplex PC - ST PC, OS1, 1m	57
R512394	Central Loose Tube Cable I/A-DQ(ZN=B)H, OM4, 12-fibers	59	R800294	Patch Cord ST PC - LC-Duplex PC, OS1, 1m	58
R512395	Central Loose Tube Cable I/A-DQ(ZN=B)H, OM4, 24-fibers	59	R800295	Patch Cord LC-Duplex PC - ST PC, OS1, 2m	57
R512396	Central Loose Tube Cable A-DQ(ZN)B2Y, OM4, 4-fibers	59	R800295	Patch Cord ST PC - LC-Duplex PC, OS1, 2m	58
R512397	Central Loose Tube Cable A-DQ(ZN)B2Y, OM4, 6-fibers	59	R800296	Patch Cord LC-Duplex PC - ST PC, OS1, 3m	57
R512398	Central Loose Tube Cable A-DQ(ZN)B2Y, OM4, 8-fibers	59	R800296	Patch Cord ST PC - LC-Duplex PC, OS1, 3m	58
R512399	Central Loose Tube Cable A-DQ(ZN)B2Y, OM4, 12-fibers	59	R800297	Patch Cord LC-Duplex PC - ST PC, OS1, 5m	57
R512400	Central Loose Tube Cable A-DQ(ZN)B2Y, OM4, 24-fibers	59	R800297	Patch Cord ST PC - LC-Duplex PC, OS1, 5m	58
R512704	Mini Breakout Cable I-V(ZN=B)H, OM4, 4-fibers	59	R800298	Patch Cord LC-Duplex PC - ST PC, OS1, 10m	57
R512705	Mini Breakout Cable I-V(ZN=B)H, OM4, 6-fibers	59	R800298	Patch Cord ST PC - LC-Duplex PC, OS1, 10m	58
R512706	Mini Breakout Cable I-V(ZN=B)H, OM4, 8-fibers	59	R800299	Patch Cord SC-Duplex PC - ST PC, OM3, M/4, 1m	57
R512707	Mini Breakout Cable I-V(ZN=B)H, OM4, 12-fibers	59	R800299	Patch Cord ST PC - SC-Duplex PC, OM3, M/4, 1m	58
R512708	Mini Breakout Cable I-V(ZN=B)H, OM4, 24-fibers	59	R800300	Patch Cord SC-Duplex PC - ST PC, OM3, M/4, 3m	57
R512763	MPO Modul 7HP, metal, MTPm - 6xLC-Duplex, OM3, PC/PC, ceramic	64	R800300	Patch Cord ST PC - SC-Duplex PC, OM3, M/4, 3m	58
R795030	Installation Cable Cat.5e, U/UTP, 4P, 200 MHz, PVC, 305m, blue	11	R800301	Patch Cord SC-Duplex PC - ST PC, OM3, M/4, 5m	57
R795069	BS Faceplate 2x1-Port, pure white	38	R800301	Patch Cord ST PC - SC-Duplex PC, OM3, M/4, 5m	58
R795069	BS Faceplate 3x1-Port, pure white	38	R800302	Patch Cord SC-Duplex PC - ST PC, OM3, M/4, 10m	57
R795070	BS Faceplate 4x1-Port, pure white	38	R800302	Patch Cord ST PC - SC-Duplex PC, OM3, M/4, 10m	58
R795078	Mini Surface Box, 4x1-Port with magnet	35	R800303	Patch Cord SC-Duplex PC - ST PC, OS1, 1m	57
R795103	Connector Kit SC, PC, SM, blue, C, 125.5, 0.9 + 2.8mm tube blue	55	R800303	Patch Cord ST PC - SC-Duplex PC, OS1, 1m	58
R795107	Block Module Holder	45	R800304	Patch Cord SC-Duplex PC - ST PC, OS1, 2m	57
R795109	Mini Surface Mount Box, 1x1-Port with magnet	35	R800304	Patch Cord ST PC - SC-Duplex PC, OS1, 2m	58
R795111	Mini Surface Box, 4x1-Port	35	R800305	Patch Cord SC-Duplex PC - ST PC, OS1, 3m	57
R795123	Connector Kit SC, PC, MM, beige, M, 127, 0.9 + 2.8mm tube beige	55	R800305	Patch Cord ST PC - SC-Duplex PC, OS1, 3m	58
R795139	19" 1U PP BASIC Cat.5e 24XRJ45/u, Gray	17	R800306	Patch Cord SC-Duplex PC - ST PC, OS1, 5m	57
R795205	19" 1U PP BASIC Cat.5e 24XRJ45/u, Black	17	R800306	Patch Cord ST PC - SC-Duplex PC, OS1, 5m	58
R795206	19" 1U PP BASIC Cat.6 24XRJ45/u, Black	17	R800307	Patch Cord SC-Duplex PC - ST PC, OS1, 10m	57
R795209	Module Holder for Third-Party Faceplate, with R&M Logo	45	R800307	Patch Cord ST PC - SC-Duplex PC, OS1, 10m	58
R800023	Patch Cord LC-Duplex PC - ST PC, OM3, M/4, 2m	57	R800308	Patch Cord ST PC 2x - ST PC 2x, OS1, 1m	57
R800023	Patch Cord ST PC - LC-Duplex PC, OM3, M/4, 2m	58	R800309	Patch Cord ST PC 2x - ST PC 2x, OS1, 3m	57
R800024	Patch Cord LC-Duplex PC - ST PC, OM3, M/4, 3m	57	R800310	Patch Cord ST PC 2x - ST PC 2x, OS1, 5m	57
R800024	Patch Cord ST PC - LC-Duplex PC, OM3, M/4, 3m	58	R800311	Patch Cord ST PC 2x - ST PC 2x, OS1, 10m	57
R800025	Patch Cord LC-Duplex PC - ST PC, OM3, M/4, 5m	57	R800312	Patch Cord SC-RJ PC - ST PC, OM3, M/4, 1m	57
R800025	Patch Cord ST PC - LC-Duplex PC, OM3, M/4, 5m	58	R800312	Patch Cord ST PC - SC-RJ PC, OM3, M/4, 1m	58
R800032	Patch Cord SC-Duplex PC - ST PC, OM3, M/4, 2m	57	R800313	Patch Cord SC-RJ PC - ST PC, OM3, M/4, 2m	57
R800032	Patch Cord ST PC - SC-Duplex PC, OM3, M/4, 2m	58	R800313	Patch Cord ST PC - SC-RJ PC, OM3, M/4, 2m	58
R800112	Patch Cord LC-Duplex PC - SC-RJ PC, OM3, M/4, 3m	58	R800314	Patch Cord SC-RJ PC - ST PC, OM3, M/4, 3m	57
R800112	Patch Cord SC-RJ PC - LC-Duplex PC, OM3, M/4, 3m	58	R800314	Patch Cord ST PC - SC-RJ PC, OM3, M/4, 3m	58
R800114	Patch Cord LC-Duplex PC - SC-RJ PC, OM3, M/4, 10m	58	R800315	Patch Cord SC-RJ PC - ST PC, OM3, M/4, 5m	57
R800114	Patch Cord SC-RJ PC - LC-Duplex PC, OM3, M/4, 10m	58	R800315	Patch Cord ST PC - SC-RJ PC, OM3, M/4, 5m	58
R800121	Patch Cord LC-Duplex PC - SC-Duplex PC, OM3, M/4, 10m	58	R800316	Patch Cord SC-RJ PC - ST PC, OM3, M/4, 10m	57
R800121	Patch Cord SC-Duplex PC - LC-Duplex PC, OM3, M/4, 10m	58	R800316	Patch Cord ST PC - SC-RJ PC, OM3, M/4, 10m	58
R800238	Patch Cord LC-Duplex PC - SC-RJ PC, OM3, M/4, 1m	58	R800317	Patch Cord SC-RJ PC - ST PC, OS1, 1m	57
R800238	Patch Cord SC-RJ PC - LC-Duplex PC, OM3, M/4, 1m	58	R800317	Patch Cord ST PC - SC-RJ PC, OS1, 1m	58
R800253	Patch Cord LC-Duplex PC - ST PC, OM1, M/4, 1m	57	R800318	Patch Cord SC-RJ PC - ST PC, OS1, 2m	57
R800253	Patch Cord ST PC - LC-Duplex PC, OM1, M/4, 1m	58	R800318	Patch Cord ST PC - SC-RJ PC, OS1, 2m	58
R800285	Patch Cord LC-Duplex PC - ST PC, OM1, M/4, 2m	57	R800319	Patch Cord SC-RJ PC - ST PC, OS1, 3m	57
R800285	Patch Cord ST PC - LC-Duplex PC, OM1, M/4, 2m	58	R800319	Patch Cord ST PC - SC-RJ PC, OS1, 3m	58
R800286	Patch Cord LC-Duplex PC - ST PC, OM1, M/4, 3m	57	R800320	Patch Cord SC-RJ PC - ST PC, OS1, 5m	57
R800286	Patch Cord ST PC - LC-Duplex PC, OM1, M/4, 3m	58	R800320	Patch Cord ST PC - SC-RJ PC, OS1, 5m	58
R800287	Patch Cord LC-Duplex PC - ST PC, OM1, M/4, 5m	57	R800321	Patch Cord SC-RJ PC - ST PC, OS1, 10m	57
R800287	Patch Cord ST PC - LC-Duplex PC, OM1, M/4, 5m	58	R800321	Patch Cord ST PC - SC-RJ PC, OS1, 10m	58
R800288	Patch Cord LC-Duplex PC - ST PC, OM1, M/4, 10m	57	R800322	Patch Cord SC-RJ PC - SC-Duplex PC, OM3, M/4, 1m	58

Part No	Product	Page No	Part No	Product	Page No
R800322	Patch Cord SC-Duplex PC - SC-RJ PC, OM3, M/4, 1m	58	R800372	Patch Cord LC-Duplex PC - LC-Duplex PC, OM1, M/4, 10m	58
R800324	Patch Cord SC-RJ PC - SC-Duplex PC, OM3, M/4, 2m	58	R800373	Patch Cord LC-Duplex PC - LC-Duplex PC, OM2, M/4, 10m	58
R800324	Patch Cord SC-Duplex PC - SC-RJ PC, OM3, M/4, 2m	58	R800374	Patch Cord ST PC 2x - ST PC 2x, OM3, M/4, 1m	57
R800325	Patch Cord SC-RJ PC - SC-Duplex PC, OM3, M/4, 3m	58	R800375	Patch Cord SC-Duplex PC - SC-Duplex PC, OM3, M/4, 1m	58
R800325	Patch Cord SC-Duplex PC - SC-RJ PC, OM3, M/4, 3m	58	R800377	Patch Cord LC-Duplex PC - SC-Duplex PC, OM1, M/4, 1m	57
R800326	Patch Cord SC-RJ PC - SC-Duplex PC, OM3, M/4, 5m	58	R800377	Patch Cord SC-Duplex PC - LC-Duplex PC, OM1, M/4, 1m	58
R800326	Patch Cord SC-Duplex PC - SC-RJ PC, OM3, M/4, 5m	58	R800378	Patch Cord LC-Duplex PC - SC-Duplex PC, OS1, 1m	58
R800327	Patch Cord SC-RJ PC - SC-Duplex PC, OM3, M/4, 10m	58	R800378	Patch Cord SC-Duplex PC - LC-Duplex PC, OS1, 1m	58
R800327	Patch Cord SC-Duplex PC - SC-RJ PC, OM3, M/4, 10m	58	R800379	Patch Cord LC-Duplex PC - SC-RJ PC, OM1, M/4, 1m	58
R800331	Patch Cord SC-RJ PC - SC-Duplex PC, OS1, 1m	58	R800379	Patch Cord SC-RJ PC - LC-Duplex PC, OM1, M/4, 1m	58
R800331	Patch Cord SC-Duplex PC - SC-RJ PC, OS1, 1m	58	R800672	Patch Cord LC-Duplex PC - SC-RJ PC, OM3, M/4, 2m	58
R800332	Patch Cord SC-RJ PC - SC-Duplex PC, OS1, 2m	58	R800672	Patch Cord SC-RJ PC - LC-Duplex PC, OM3, M/4, 2m	58
R800332	Patch Cord SC-Duplex PC - SC-RJ PC, OS1, 2m	58	R800816	Patch Cord Cat.6, U/UTP, 4P, LSZH, RJ45/u-RJ45/u, 15.0m, red	30
R800333	Patch Cord SC-RJ PC - SC-Duplex PC, OS1, 3m	58	R800818	Patch Cord Cat.6, U/UTP, 4P, LSZH, RJ45/u-RJ45/u, 7.5m, yellow	30
R800333	Patch Cord SC-Duplex PC - SC-RJ PC, OS1, 3m	58	R800819	Patch Cord Cat.6, U/UTP, 4P, LSZH, RJ45/u-RJ45/u, 15.0m, yellow	30
R800334	Patch Cord SC-RJ PC - SC-Duplex PC, OS1, 5m	58	R800822	Patch Cord Cat.6, U/UTP, 4P, LSZH, RJ45/u-RJ45/u, 15.0m, blue	30
R800334	Patch Cord SC-Duplex PC - SC-RJ PC, OS1, 5m	58	R800910	Patch Cord Cat.6, U/UTP, 4P, LSZH, RJ45/u-RJ45/u, 15.0m, green	30
R800335	Patch Cord SC-RJ PC - SC-Duplex PC, OS1, 10m	58	R801683	Patch Cord Cat.6, U/UTP, 4P, LSZH, RJ45/u-RJ45/u, 12.5m, yellow	30
R800335	Patch Cord SC-Duplex PC - SC-RJ PC, OS1, 10m	58	R801686	Patch Cord Cat.6, U/UTP, 4P, LSZH, RJ45/u-RJ45/u, 20.0m, yellow	30
R800336	Patch Cord SC-RJ PC - SC-RJ PC, OM3, M/4, 1m	58	R801689	Patch Cord Cat.6, U/UTP, 4P, LSZH, RJ45/u-RJ45/u, 12.5m, red	30
R800337	Patch Cord SC-RJ PC - SC-RJ PC, OM3, M/4, 2m	58	R801692	Patch Cord Cat.6, U/UTP, 4P, LSZH, RJ45/u-RJ45/u, 20.0m, red	30
R800338	Patch Cord SC-RJ PC - SC-RJ PC, OM3, M/4, 3m	58	R801694	Patch Cord Cat.6, U/UTP, 4P, LSZH, RJ45/u-RJ45/u, 12.5m, blue	30
R800339	Patch Cord SC-RJ PC - SC-RJ PC, OM3, M/4, 5m	58	R801697	Patch Cord Cat.6, U/UTP, 4P, LSZH, RJ45/u-RJ45/u, 12.5m, green	30
R800340	Patch Cord SC-RJ PC - SC-RJ PC, OM3, M/4, 10m	58	R802296	Patch Cord Cat.5e Light, U/UTP, 4P, LSOH, 3.0m	32
R800341	Patch Cord SC-RJ PC - SC-RJ PC, OS1, 1m	58	R802309	Patch Cord Cat.5e Light, U/UTP, 4P, LSOH, 5.0m	32
R800342	Patch Cord SC-RJ PC - SC-RJ PC, OS1, 2m	58	R802310	Patch Cord Cat.5e Light, U/UTP, 4P, LSOH, 2.0m	32
R800343	Patch Cord SC-RJ PC - SC-RJ PC, OS1, 3m	58	R802906	Patch Cord Cat.5e Light, U/UTP, 4P, LSOH, 1.5m	32
R800344	Patch Cord SC-RJ PC - SC-RJ PC, OS1, 5m	58	R802907	Patch Cord Cat.5e Light, U/UTP, 4P, LSOH, 1.0m	32
R800345	Patch Cord SC-RJ PC - SC-RJ PC, OS1, 10m	58	R803255	Patch Cord LC-Duplex PC - SC-RJ PC, OM3, M/4, 5m	58
R800346	Patch Cord LC-Duplex PC - SC-RJ PC, OS1, 1m	58	R803255	Patch Cord SC-RJ PC - LC-Duplex PC, OM3, M/4, 5m	58
R800346	Patch Cord SC-RJ PC - LC-Duplex PC, OS1, 1m	58	R925370	Connection Module Cat.5e, 1xRJ45/s	5
R800347	Patch Cord LC-Duplex PC - SC-RJ PC, OS1, 2m	58	R925371	Connection Module Cat.5e, 1xRJ45/u	5
R800347	Patch Cord SC-RJ PC - LC-Duplex PC, OS1, 2m	58	R925719	Universal Blind Cover, pure white	29
R800348	Patch Cord LC-Duplex PC - SC-RJ PC, OS1, 3m	58	R925719	Blind Cover Universal, pure white	45
R800348	Patch Cord SC-RJ PC - LC-Duplex PC, OS1, 3m	58	R925728	Mini Surface Box, 2x1-Port, pure white	35
R800349	Patch Cord LC-Duplex PC - SC-RJ PC, OS1, 5m	58	R925822	US Style Faceplate 72x117.5, 6x1-Port, pure white	41
R800349	Patch Cord SC-RJ PC - LC-Duplex PC, OS1, 5m	58	R925824	US Style Mounting Box, pure white	41
R800350	Patch Cord LC-Duplex PC - SC-RJ PC, OS1, 10m	58	R925842	Mounting Plate "Fascia" 25x50, 1-Port, pure white	40
R800350	Patch Cord SC-RJ PC - LC-Duplex PC, OS1, 10m	58	R925895	Shuttered "Fascia" 86x86, 2x1-Port, pure white	40
R800352	Patch Cord ST PC 2x - ST PC 2x, OM1, M/4, 10m	57	R925897	Blind Cover "Fascia" 25x50, 1-Port, pure white	40
R800353	Patch Cord ST PC 2x - ST PC 2x, OM2, M/4, 10m	57	On request	Central Loose Tube Cable A-D(ZN)W2Y, OM4, 6-fibers	59
R800354	Patch Cord ST PC 2x - ST PC 2x, OM3, M/4, 10m	57	On request	Central Loose Tube Cable A-D(ZN)W2Y, OM4, 8-fibers	59
R800355	Patch Cord SC-Duplex PC - ST PC, OM1, M/4, 10m	57	On request	Central Loose Tube Cable A-D(ZN)W2Y, OM4, 12-fibers	59
R800355	Patch Cord ST PC - SC-Duplex PC, OM1, M/4, 10m	57	On request	Central Loose Tube Cable A-D(ZN)W2Y, OM4, 24-fibers	59
R800356	Patch Cord SC-Duplex PC - ST PC, OM2, M/4, 10m	57	On request	Mini Breakout Cable I-V(ZN=B)H, OM4, 2-fibers	59
R800356	Patch Cord ST PC - SC-Duplex PC, OM2, M/4, 10m	57	On request	Stranded Loose Tube Cables A-DF(ZN)2YW2Y, OM4, 1x12-fibers	59
R800357	Patch Cord SC-Duplex PC - SC-Duplex PC, OM1, M/4, 10m	57	On request	Stranded Loose Tube Cables A-DF(ZN)2YW2Y, OM4, 2x12-fibers	59
R800358	Patch Cord SC-Duplex PC - SC-Duplex PC, OM2, M/4, 10m	57	On request	Stranded Loose Tube Cables A-DF(ZN)2YW2Y, OM4, 4x12-fibers	59
R800359	Patch Cord SC-Duplex PC - SC-Duplex PC, OM3, M/4, 10m	58	On request	Stranded Loose Tube Cables A-DF(ZN)2YW2Y, OM4, 6x12-fibers	59
R800360	Patch Cord SC-RJ PC - ST PC, OM1, M/4, 10m	57	On request	Stranded Loose Tube Cables A-DF(ZN)2YW2Y, OM4, 8x12-fibers	59
R800360	Patch Cord ST PC - SC-RJ PC, OM1, M/4, 10m	58			
R800361	Patch Cord SC-RJ PC - ST PC, OM2, M/4, 10m	57			
R800361	Patch Cord ST PC - SC-RJ PC, OM2, M/4, 10m	58			
R800362	Patch Cord SC-RJ PC - SC-Duplex PC, OM1, M/4, 10m	57			
R800362	Patch Cord SC-Duplex PC - SC-RJ PC, OM1, M/4, 10m	58			
R800363	Patch Cord SC-RJ PC - SC-Duplex PC, OM2, M/4, 10m	57			
R800363	Patch Cord SC-Duplex PC - SC-RJ PC, OM2, M/4, 10m	58			
R800365	Patch Cord SC-RJ PC - SC-RJ PC, OM2, M/4, 10m	58			
R800366	Patch Cord LC-Duplex PC - SC-Duplex PC, OM2, M/4, 10m	57			
R800366	Patch Cord SC-Duplex PC - LC-Duplex PC, OM2, M/4, 10m	58			
R800370	Patch Cord LC-Duplex PC - SC-RJ PC, OM1, M/4, 10m	58			
R800370	Patch Cord SC-RJ PC - LC-Duplex PC, OM1, M/4, 10m	58			
R800371	Patch Cord LC-Duplex PC - SC-RJ PC, OM2, M/4, 10m	58			
R800371	Patch Cord SC-RJ PC - LC-Duplex PC, OM2, M/4, 10m	58			

ON FITS ALL

Pat. pending

FM45 CONNECTOR. This is the first tool-free, field-terminable Gigabit connector for 8-pin connections. It is perfect for structured cabling systems, enterprise networks, home cabling, Industrial Ethernet and bus installations.

FUNCTION. With the FM45, transmission capacities can be provided for network operations up to Gigabit Ethernet. And it is quite simple. The

familiar and proven insulation displacement contact from R&M makes assembly very quick. Stripping of the individual conductors is not necessary and no special wiring tool is needed.

GET MORE. Obtain maximum reliability thanks to IDC and a fixed contact with more freedom in cabling. Every second and movement counts on the construction site. The simpler the installation, the quicker you can react to

acute situations. You are gaining more latitude and flexibility in construction, modifications, maintenance and repairs of networks with copper cabling and RJ45 connections. For more information visit www.rdm.com

 **R&M**

Convincing cabling solutions

Product data online

The entire R&M product line can also be found online with plenty of additional information and extra functionality. For example, with a few clicks, you can produce a comprehensive and professional attachment to your quotations or extensive documentation of selected products for your customer or your own project.

www.rdm.com/universe

The way to the product



Menu with identical structure as in the printed version.

Search with R-number or product name.

010.3630

The product page

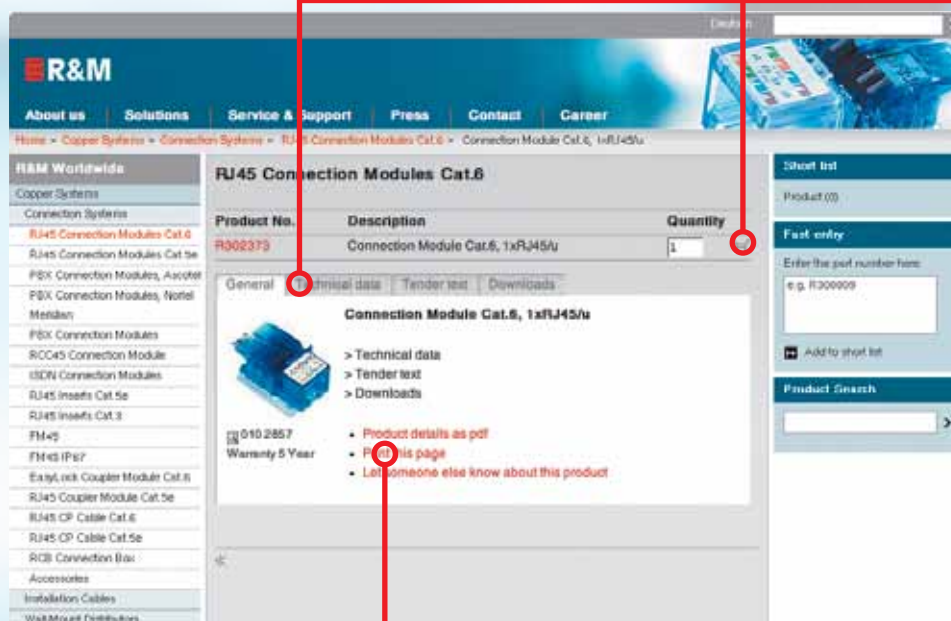

Collect interesting products in a shortlist.

Find comprehensive information on the product from the tabs.

Use the information directly: as a print-out, as a PDF, or send an e-mail to a colleague.

010.3631

www.rdm.com

Headquarters Switzerland

Reichle & De-Massari
Binzstrasse 31
CHE-8620 Wetzikon/Switzerland
Tel: +41 (0)44 933 81 11
Fax: +41 (0)44 930 49 41

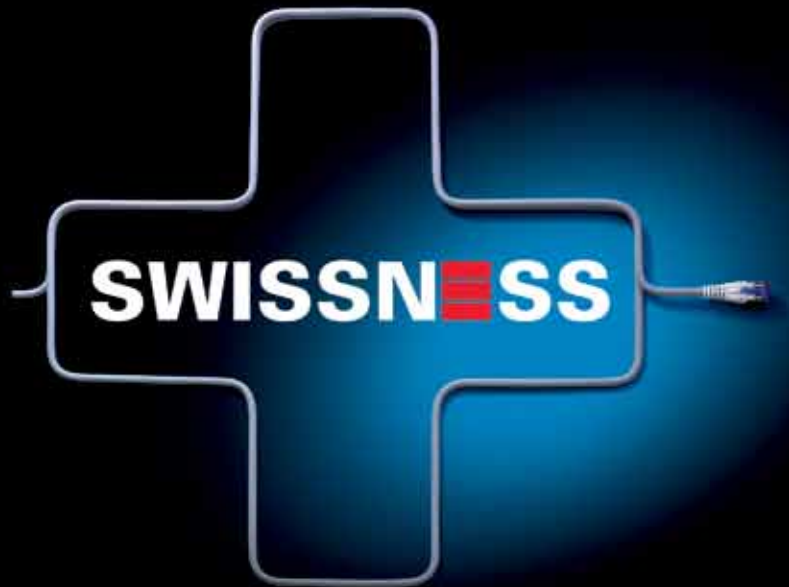

Your R&M partners in Asia-Pacific

Singapore

(Head office Asia-Pacific)
Reichle & De-Massari
Far East (Pte) Ltd
20 Toh Guan Road
#04-00 CJ GLS Building
Singapore 608839
Tel: +65 6506 5600
Fax: +65 6566 9925
sgp@rdm.com

Australia

Reichle & De-Massari
Australia Pty Ltd
Level 13, Macquarie House
167 Macquarie Street
Sydney NSW 2000
Tel: +61 409 674 738
aus@rdm.com

**Greater China Group
Shanghai**

Reichle & De-Massari
China Co Ltd
Unit 501, No. 538
West Jiangchang Road
200436 Shanghai, P.R.China
Tel: +86 (21) 3632 1933
Fax: +86 (21) 3632 1911
chn@rdm.com

India

R&M India Pvt. Ltd
#90/4, JP Royale, 3rd Floor
Outer Ring Road, Marathahalli
Bangalore - 560 037, India
Tel: +91 80 40792601
Fax: +91 80 40792604
ind@rdm.com

Japan

Reichle & De-Massari
Far East (Pte) Ltd
Nagamine Bldg. 4F
Kami-Osaki 3-3-6,
Shinagawa-ku
141-0021 Tokyo
Tel: +81 3 5789 1160
Fax: +81 3 5789 1161
jpn@rdm.com

Korea

Reichle & De-Massari Korea
Taehyeon Building 3F
305, Namhyeon-dong 602-27
Gwanak-gu
Seoul 151-801 Korea
Tel: +82 2 3462 0158
Fax: +82 2 3461 0160
kor@rdm.com